

---

# BuzziShield Free Product Specification Sheet

---

This document contains technical  
information about the BuzziShield Free

---



[www.buzzi.space](http://www.buzzi.space)



## A cozy office divider





BuzziShield Free is unlike your usual room and office dividers and won't create a cold atmosphere as its glass or plastic counterparts do. Due to its voluminous upholstered body, this divider effectively absorbs sound while adding a colorful element into any workspace. The lightweight and adaptable BuzziShield Free works well on its own as a partition between desks to create private workstations for both seated and standing desks. Or combine more than one to introduce natural flows in an open space.

The versatile BuzziShield Free arrives in two different heights, Medium (150 cm/ 59") and High (180 cm/71"); two different widths (120 cm/47" and 160 cm/63"); and can be dressed in a variety of fabrics and colors to suit your decor needs. You can also pin notes, pictures, or whatever you like into BuzziShield Free to truly make it your own.

Design by BuzziSpace Studio

---

## General

-  BuzziShield Free  
Free | Arc  
Medium | High
-  Upholstered acoustic foam element  
Baseplate: powder coated metal in black (RAL 9005)  
Cover: Fabric, Trevira CS, Reflect, Revive 1, Velvet, Clara 2, Remix 3, Hero 2, Tonus 4, Arda, Memory 2
-  Dry Use
-  Flat Packed  
Unassembled

---

## Acoustics



---

## Content

Configurations	3
Components	4
Fabrics	5
Dimensions	10
Acoustics	14

# Configuration

---

## BuzziShield Free Medium

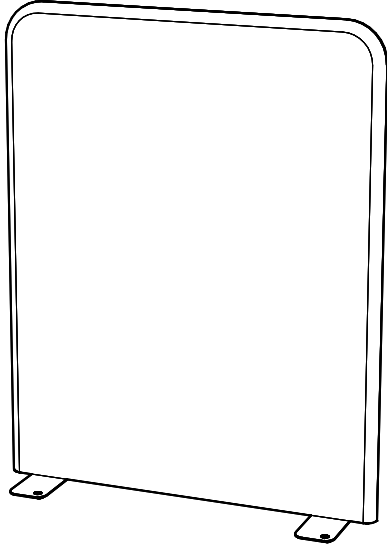

- 🌲 Upholstered acoustic foam element  
Baseplate: powder coated metal in black (RAL 9005)  
Cover: Fabric, Trevira CS, Reflect, Revive 1, Velvet, Clara 2, Remix 3, Hero 2, Tonus 4, Arda, Memory 2
- ✂ Height: 150 cm | 59.06"  
✂ Width: 120 cm or 160 cm  
47.24" or 62.99"
- ⚖ Width 120 cm: 11,4 kg | 25.13 lbs  
Width 160 cm: 15,3 kg | 33.73 lbs

---

## BuzziShield Free Arc Medium

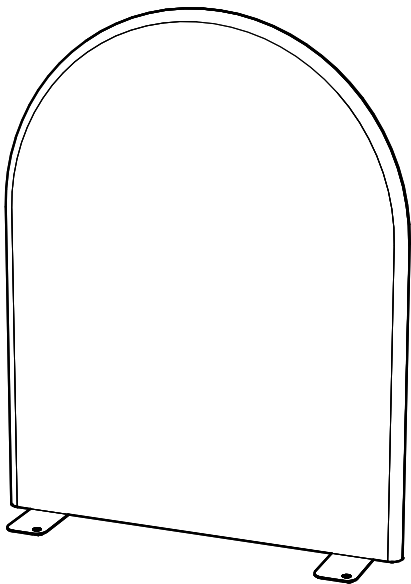



- 🌲 Upholstered acoustic foam element  
Baseplate: powder coated metal in black (RAL 9005)  
Cover: Fabric, Trevira CS, Reflect, Revive 1, Velvet, Clara 2, Remix 3, Hero 2, Tonus 4, Arda, Memory 2
- ✂ Height: 150 cm | 59.06"  
✂ Width: 120 cm or 160 cm  
47.24" or 62.99"
- ⚖ Width 120 cm: 11 kg | 24.25 lbs  
Width 160 cm: 13,5 kg | 29.76 lbs

---

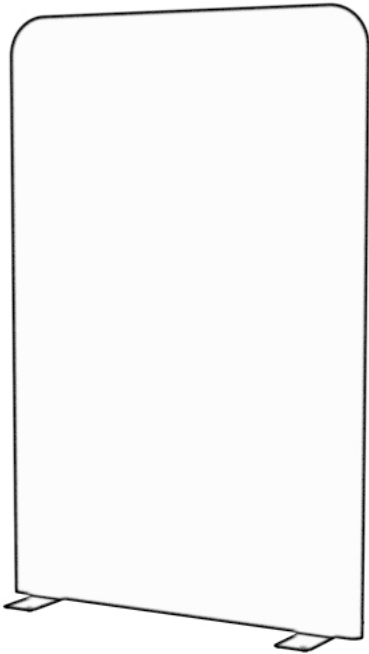
## BuzziShield Free High





-  Upholstered acoustic foam element  
Baseplate: powder coated metal in black (RAL 9005)  
Cover: Fabric, Trevira CS, Reflect, Revive 1, Velvet, Clara 2, Remix 3, Hero 2, Tonus 4, Arda, Memory 2
-  Height: 180 cm | 70.87"  
Width: 120 cm or 160 cm  
47.24" or 62.99"
-  Width 120 cm: 12,85 kg | 28.33 lbs  
Width 160 cm: 17 kg | 37.48 lbs

---

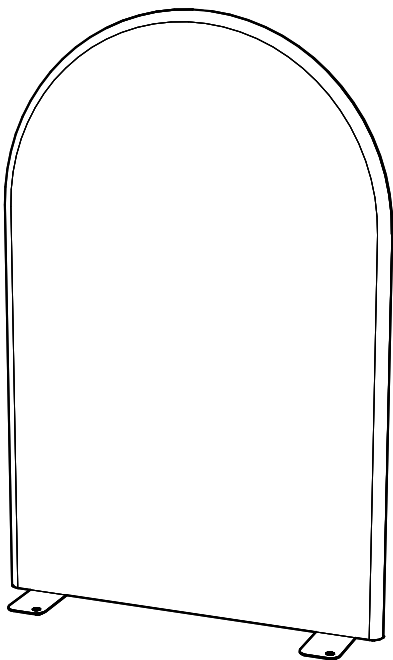
## BuzziShield Free Arc High



-  Upholstered acoustic foam element  
Baseplate: powder coated metal in black (RAL 9005)  
Cover: Fabric, Trevira CS, Reflect, Revive 1, Velvet, Clara 2, Remix 3, Hero 2, Tonus 4, Arda, Memory 2
-  Height: 180 cm | 70.87"  
Width: 120 cm or 160 cm  
47.24" or 62.99"
-  Width 120 cm: 12,5 kg | 27.56 lbs  
Width 160 cm: 16 kg | 35.27 lbs

# Components

---

## Baseplate

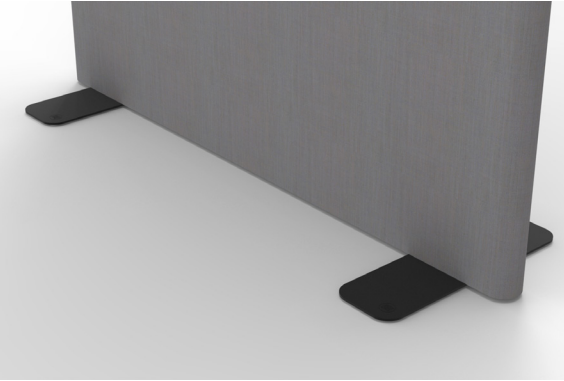

2 baseplates included in powder coated black metal (RAL 9005)

# Fabrics

## Fabric (45 colors)

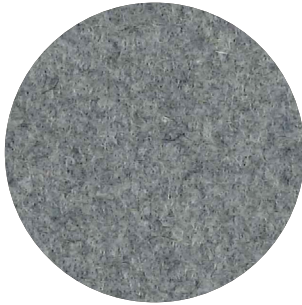

**Category A**

**Composition** 70% Recycled Wool, 25% Recycled Polyacryl,  
5% Recycled Other Fabrics

**Weight** 405 g/m<sup>2</sup> | 11.94 oz/yd<sup>2</sup>

**Abrasion resistance** 40.000 Martindale, 50,000 Wyzenbeek

**Flammability** EU: EN 1021.1/2006 | BS EN 1021.1/2006 (cigarette).  
EN 1021.2/2006 | BS EN 1021.2/2006 (match)  
USA: CAL TB 117 | ASTM E84 CLASS A

**Fastness to light** EU: 4 | USA 4

**Fastness to rubbing** EU: Wet 3-4 | Dry 4-5

**Fastness to crocking** USA: Wet 5 | Dry 5



## Trevira CS (45 colors)

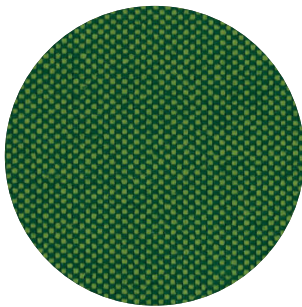

**Category A**

**Weight** 420 g/m<sup>2</sup> | 12.39 oz/yd<sup>2</sup>

**Composition** 100% Polyester, Trevira CS

**Abrasion resistance** 100.000 Martindale, 90,000 Wyzenbeek

**Flammability** BS 5852 part II: CRIB 5 | BS 7176 Medium Hazard  
USA: CAL TB 117 | M1 | B1 | EN 1021/1-2 | C1 |  
IMO Res. A652 (16)

**Fastness to light** EU: 6 | USA 5

**Fastness to rubbing** EU: Wet 4-5 | Dry 4-5

**Fastness to crocking** USA: Wet 5 | Dry 5



## Reflect (34 colors)

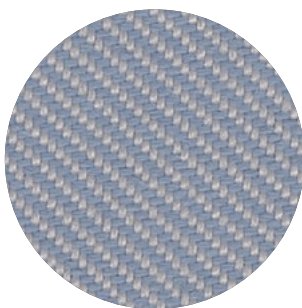

**Category A**

**Weight** 430 g/m<sup>2</sup> | 13.78 oz/yd<sup>2</sup>

**Composition** 100% Post-consumer recycled polyester

**Abrasion resistance** 100.000 Martindale

**Flammability** AS/NZS 3837 class 1 | ASTM E84 Class A Unadhered

ASTM E84 Class B Adhered | BS 5852 crib 5 with treatment

BS 5852 part 1 with treatment | EN 1021-1/2 | US Cal. Bull. 117-2013

**Fastness to light** Note 5-7, ISO 105-B02

**Fastness to rubbing** EU: Wet 5-5 | Dry 5-5

**Pilling** Note 4, EN ISO 12945



kvadrat

## Revive 1 (25 colors)

kvadrat

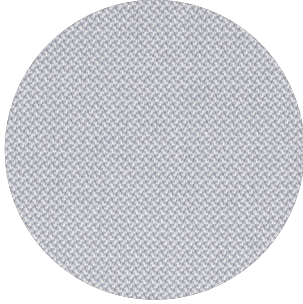

**Category A**

**Composition** 100% recycled polyester FR

**Weight** 430 g/lin.m

**Abrasion resistance** 60.000 Martindale rubs, EN ISO 12947

**Flammability** EN 1021-1/2 | DIN 4102 B1 | Önorm B1/Q1  
UNI 9175 11M | US Cal. Tech. Bull. 117  
IMO A.652 (16)

**Fastness to light** Note 5-7, ISO 105-B02

**Fastness to rubbing** (ISO) dry 5, wet 4-5

**Pilling** Note 4-5, EN ISO 12945



## Velvet (12 colors)

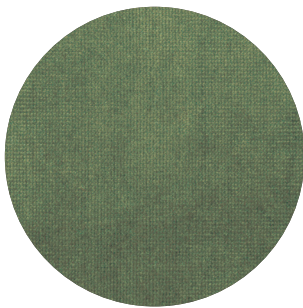

**Category B**

**Composition** 100% PES

**Weight** 375 g/m<sup>2</sup> | 11.06 oz/yd<sup>2</sup>

**Abrasion resistance** > 100.000 Martindale

**Fastness to light** EU: 4-5

**Fastness to rubbing** EU: Wet 4 | Dry 4-5

**Pilling** EU: 4-5

## Clara 2 (24 colors)

kvadrat

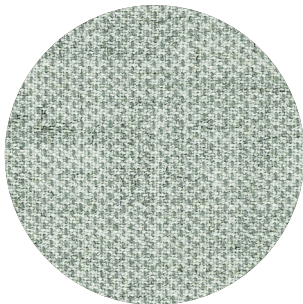

**Category B**

**Composition** 92% new wool, 8% nylon

**Weight** 400 g/lin.m

**Abrasion resistance** 80.000 Martindale rubs, EN ISO 12947

**Flammability** EN 1021-1/2 | BS 5852, ignition source 2-3 | DIN 4102 B2  
NF D 60 013 | UNI 9175 11M | US Cal. Tech. Bull. 117, Sec. E  
NFPA 260 | IMO A.652(16)

**Fastness to light** Note 5-7, ISO 105-B02

**Fastness to rubbing** (ISO) dry 4-5, wet 4

**Pilling** Note 4, EN ISO 12945



## Remix 3 (73 colors)

kvadrat



**Category B**

**Composition** 90% new wool, 10% nylon

**Weight** 415 g/lin.m

**Abrasion resistance** 100.000 Martindale rubs, EN ISO 12947

**Flammability** EN 1021-1/2 | BS 5852 part 1  
Önorm B1/Q1 | NF D 60 013 | UNI 9175, 11M  
AS/NZS 1530.3 | Cal. Tech. Bull. 117-2013  
NFPA 260 | IMO FTP Code 2010:Part 8

**Fastness to light** Note 5-7, ISO 105-B02

**Fastness to rubbing** (ISO) dry 4-5, wet 4

**Pilling** Note 4, EN ISO 12945



## Hero 2 (33 colors)

kvadrat

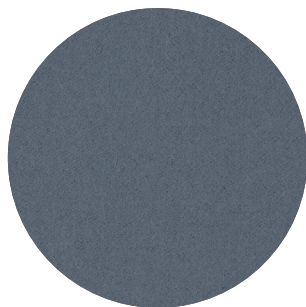

**Category C**

**Composition** 97% new wool, 3% nylon

**Weight** 580 g/lin.m

**Abrasion resistance** 45.000 Martindale rubs, EN ISO 12947

**Flammability** EN 1021-1/2 | DIN 4102 B2 | NF D 60 013  
UNI 9175 11M | US Cal. Bull. 117-2013 | NFPA 260  
IMO A.652 (16)

**Fastness to light** Note 5-6, ISO 105-B02

**Fastness to rubbing** (ISO) dry 4-5, wet 4-5

**Pilling** Note 3-4, EN ISO 12945



## Tonus 4 (47 colors)

kvadrat



**Category D**

**Composition** 90% new wool, 10% Helanca

**Weight** 665 g/lin.m

**Abrasion resistance** 100.000 Martindale rubs, EN ISO 12947

**Flammability** EN 1021-1/2 | BS 5852 part 1 | DIN 4102 B2  
Önorm B1/Q1 | NF D 60 013 | UNI 9175 11M  
US Cal. Bull. 117-2013 | NFPA 260 | IMO A.652 (16)

**Fastness to light** Note 5-7, ISO 105-B02

**Fastness to rubbing** (ISO) dry 3-5, wet 3-5

**Pilling** Note 3, EN ISO 12945



## Arda (12 colors)

kvadrat

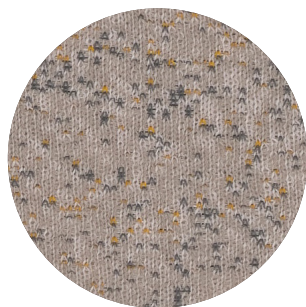

**Category E**

**Composition** 70% new wool 21% polyester 9% nylon

**Weight** 800 g/lin. m | 25.8 oz/ly

**Abrasion resistance**

Approx. 50.000 Martindale rubs, EN ISO 12947

**Flammability** ASTM E84 Class A Unadhered | AS/NZS 3837 class 2 | BS 5852 part 1  
BS 5852 crib 5 | DIN 4102 B2 | EN 1021-1/2 | IMO FTP Code 2010 Part 8  
UNI 9175 11M | US Cal. Bull. 117-2013

**Fastness to light** Note 5-8, ISO 105-B02

**Fastness to rubbing** Dry note 3-5 ISO 105-X12  
Wet note 3-5 ISO 105-X12

**Pilling** Note 4, EN ISO 12945





# Memory 2 (20 colors)

kvadrat

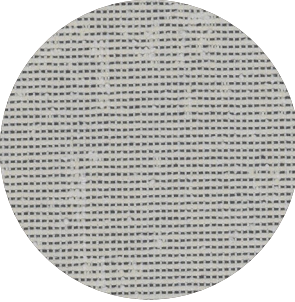

**Category** E

**Composition** 100% Trevira CS

**Weight** 700 g/lin.m

**Abrasion resistance**

35.000 rubs acc. to the Martindale method, EN ISO 12947

**Flammability** EN 1021-1/2 | DIN 4102 B1 | Önorm B1/Q1  
NF D 60 013 | NF P 92 507 M1 | UNI 9175 11M  
UNI 9177 classe 1 | US Cal. Tech. Bull. 117  
IMO A.652 (16)

**Fastness to light** Note 5-8, ISO 105-B02

**Fastness to rubbing** (ISO) dry 4-5, wet 4-5

**Pilling** Note 4, EN ISO 12945



# Dimensions

## BuzziShield Free | Free Arc Medium

Width 120 cm | 47.24"

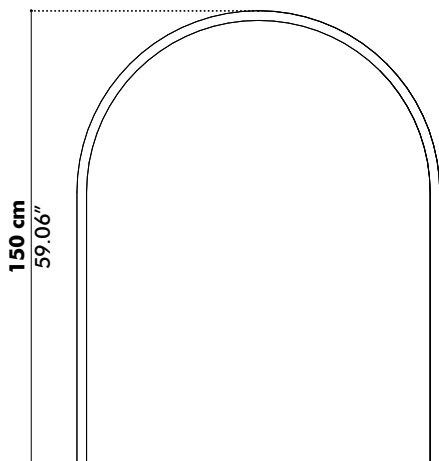
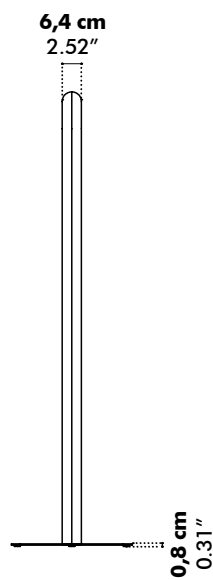
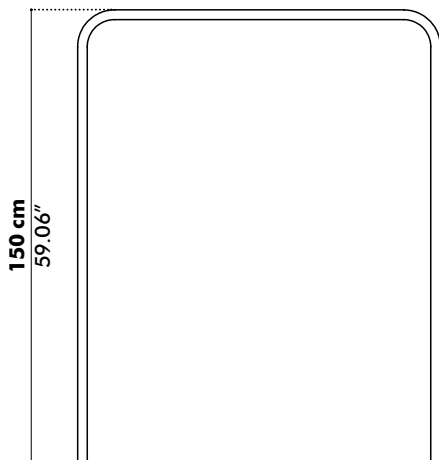
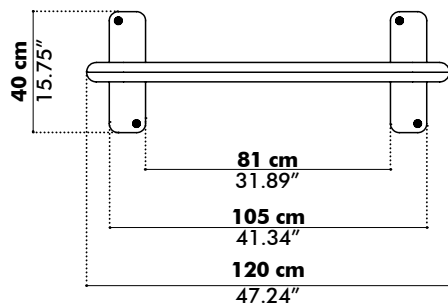

---

# BuzziShield Free | Free Arc Medium

Width 160 cm | 62.99"

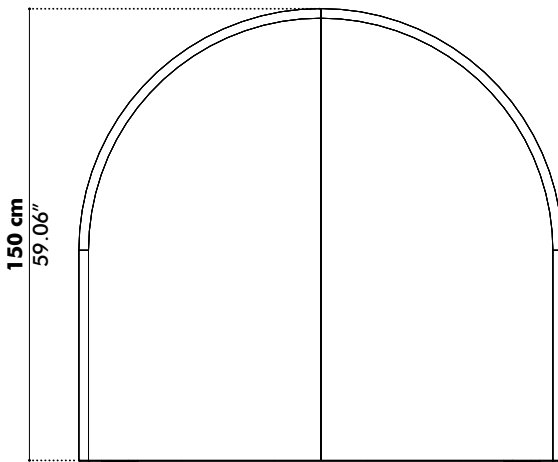
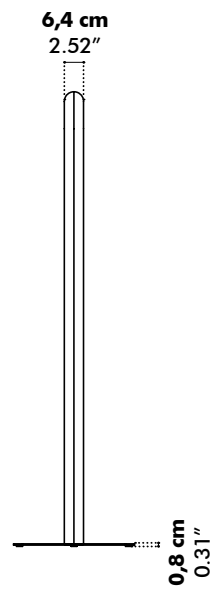
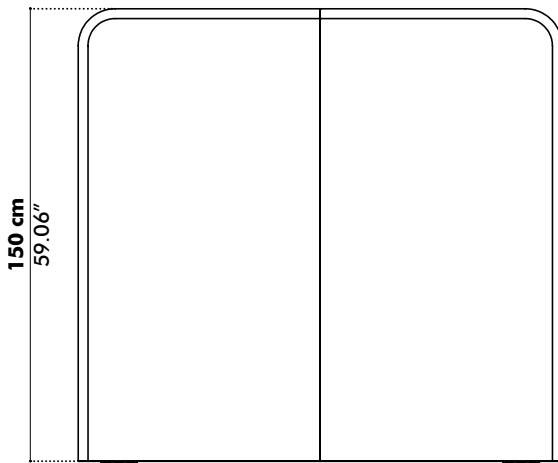
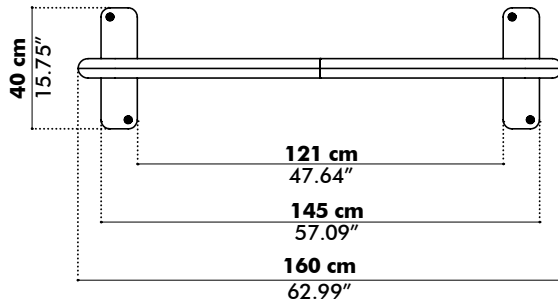

---

# BuzziShield Free | Free Arc High

Width 120 cm | 47.24"

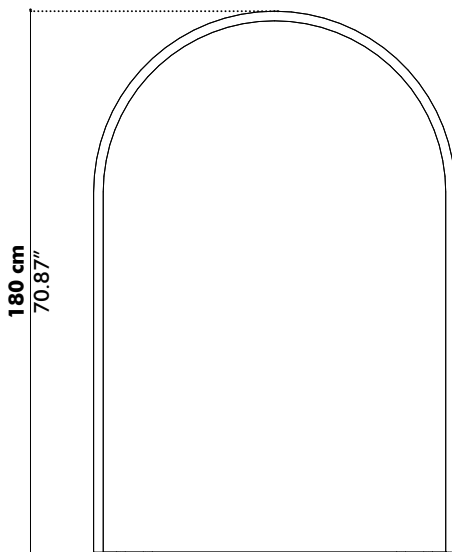
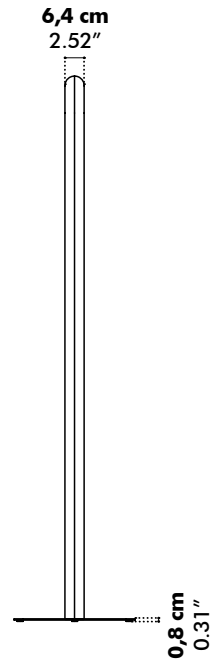
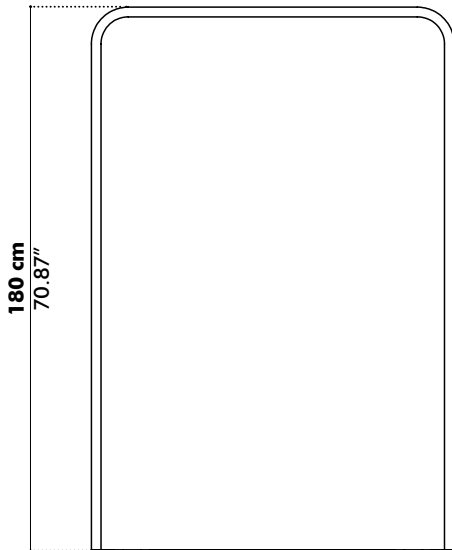
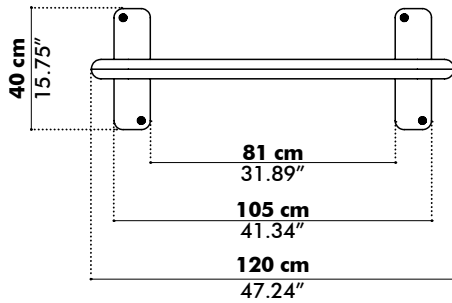

# BuzziShield Free | Free Arc High

Width 160 cm | 62.99"

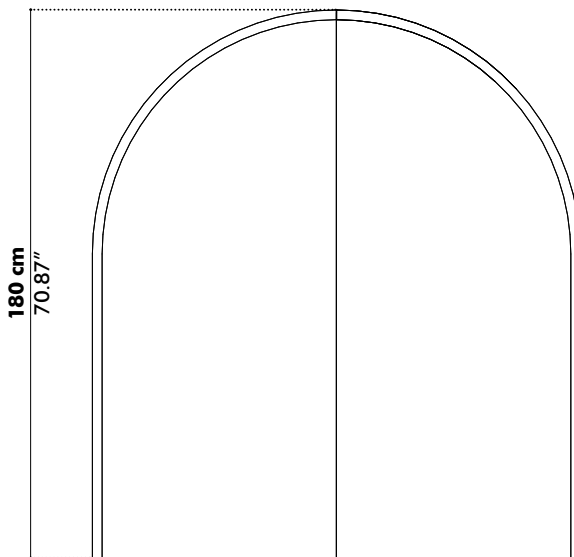
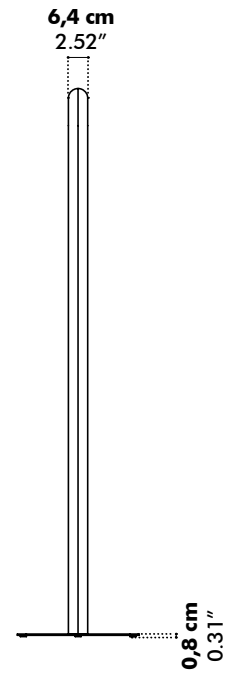
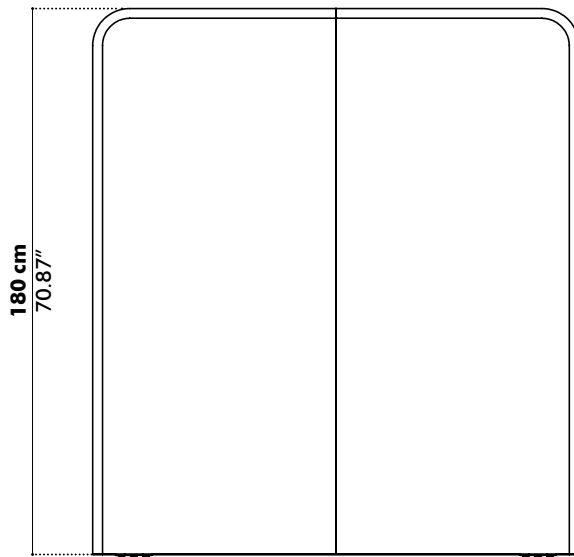
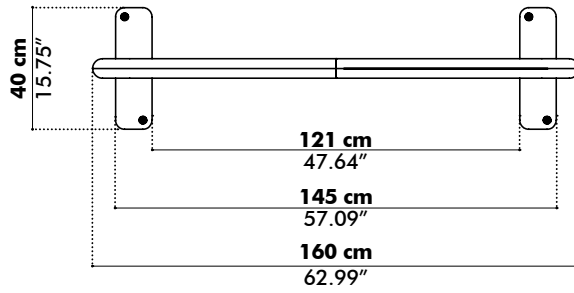

# Acoustics

## BuzziShield Free

Equivalent sound absorption area in m<sup>2</sup> per object

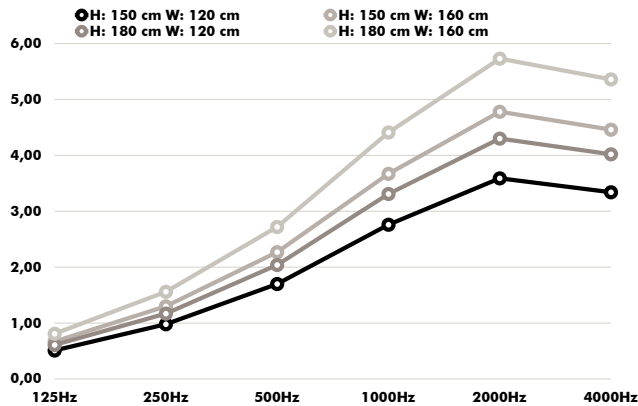

Hz	H: 150 cm W: 120 cm 59.06" 47.24" Aeq/m <sup>2</sup>	H: 150 cm W: 160 cm 59.06" 62.99" Aeq/m <sup>2</sup>	H: 180 cm W: 120 cm 70.87" 47.24" Aeq/m <sup>2</sup>	H: 180 cm W: 160 cm 70.87" 62.99" Aeq/m <sup>2</sup>
125	0.51	0.67	0.61	0.81
250	0.98	1.30	1.17	1.56
500	1.70	2.27	2.04	2.72
1000	2.76	3.67	3.31	4.41
2000	3.59	4.78	4.30	5.73
4000	3.34	4.46	4.02	5.36

## BuzziShield Free Arc

Equivalent sound absorption area in m<sup>2</sup> per object

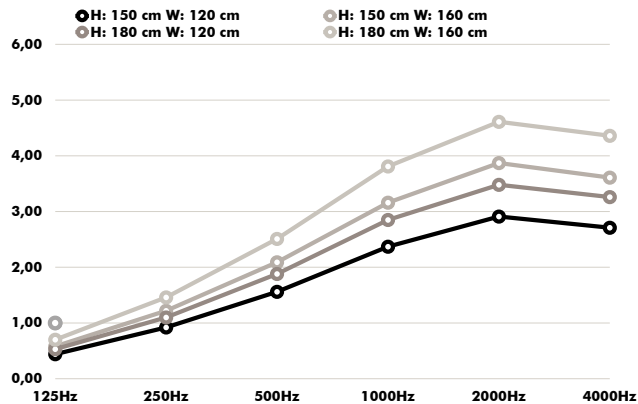

Hz	H: 150 cm W: 120 cm 59.06" 47.24" Aeq/m <sup>2</sup>	H: 150 cm W: 160 cm 59.06" 62.99" Aeq/m <sup>2</sup>	H: 180 cm W: 120 cm 70.87" 47.24" Aeq/m <sup>2</sup>	H: 180 cm W: 160 cm 70.87" 62.99" Aeq/m <sup>2</sup>
125	0.44	0.58	0.53	0.70
250	0.92	1.22	1.10	1.46
500	1.56	2.09	1.88	2.51
1000	2.37	3.16	2.85	3.81
2000	2.91	3.87	3.48	4.61
4000	2.71	3.61	3.26	4.36