BuzziPixl

Product Specification Sheet

This document contains technical information about the BuzziPixl



www.buzzi.space

Modular PET Felt Wall Panels for Creative Acoustic Walls

BuzziPixl is a modular acoustic wall panel system made from 60% recycled PET Felt. Square panels can be combined in multiple techniques and orientations to create customized wall patterns while improving acoustic comfort in interior environments.

Design by BuzziSpace Studio

General

-  Wall Tile
-  PET Felt
-  Dry Use
-  Wall Mounted

Acoustics



Absorption



Mid tone



High tone

Content

Configurations	3
Inspirational layouts	7
Mounting	13
Fabrics	13
Material	14
Dimensions	15
Acoustics	17

Configurations

BuzziPixl Plain

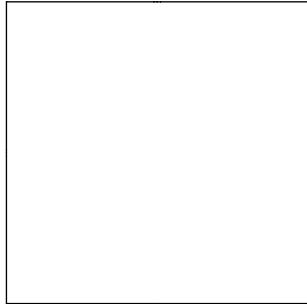

PET Felt
Wall Mounted



Height: 59,5 cm Width 59,5 cm Thickness: 0,12 cm
Height: 23.43" Width 23.43" Thickness: 0.47"



± 0,9 kg | ± 1,98 lbs



Sold exclusively in sets of 8 wall tiles, 1 set = 8 wall tiles in one color and in one pattern.

BuzziPixl Parallel Up

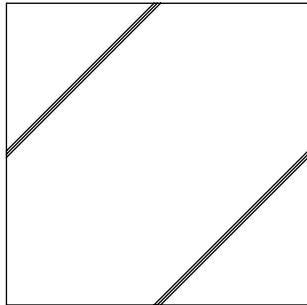

PET Felt
Wall Mounted



Height: 59,5 cm Width 59,5 cm Thickness: 0,12 cm
Height: 23.43" Width 23.43" Thickness: 0.47"



± 0,9 kg | ± 1,98 lbs



Sold exclusively in sets of 8 wall tiles, 1 set = 8 wall tiles in one color and in one pattern.

Great to combine with BuzziPixl Parallel Down or BuzziPixl Geo.

BuzziPixl Parallel Down

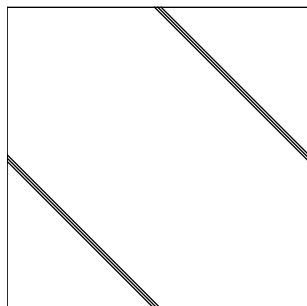

PET Felt
Wall Mounted



Height: 59,5 cm Width 59,5 cm Thickness: 0,12 cm
Height: 23.43" Width 23.43" Thickness: 0.47"



± 0,9 kg | ± 1,98 lbs



Sold exclusively in sets of 8 wall tiles, 1 set = 8 wall tiles in one color and in one pattern.

Great to combine with BuzziPixl Parallel Up or BuzziPixl Geo.

BuzziPixl Geo

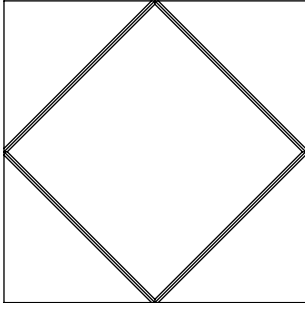

 PET Felt
Wall Mounted

 Height: 59,5 cm Width 59,5 cm Thickness: 0,12 cm
Height: 23.43" Width 23.43" Thickness: 0.47"

 ± 0,9 kg | ± 1,98 lbs

... Sold exclusively in sets of 8 wall tiles, 1 set = 8 wall tiles in one color and in one pattern.

Great to combine with BuzziPixl Parallel Up or Down.

BuzziPixl Cosmos

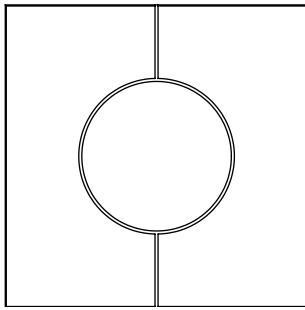

 PET Felt
Wall Mounted

 Height: 59,5 cm Width 59,5 cm Thickness: 0,12 cm
Height: 23.43" Width 23.43" Thickness: 0.47"

 ± 0,9 kg | ± 1,98 lbs

... Sold exclusively in sets of 8 wall tiles, 1 set = 8 wall tiles in one color and in one pattern.

Great to combine with BuzziPixl Abacus.

BuzziPixl Abacus

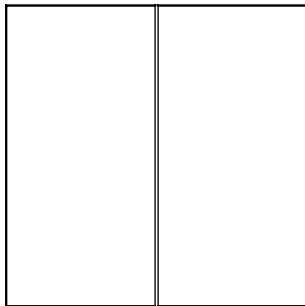

 PET Felt
Wall Mounted

 Height: 59,5 cm Width 59,5 cm Thickness: 0,12 cm
Height: 23.43" Width 23.43" Thickness: 0.47"

 ± 0,9 kg | ± 1,98 lbs

... Sold exclusively in sets of 8 wall tiles, 1 set = 8 wall tiles in one color and in one pattern.

Great to combine with BuzziPixl Cosmos

BuzziPixl Cosmos Abacus Combi 1

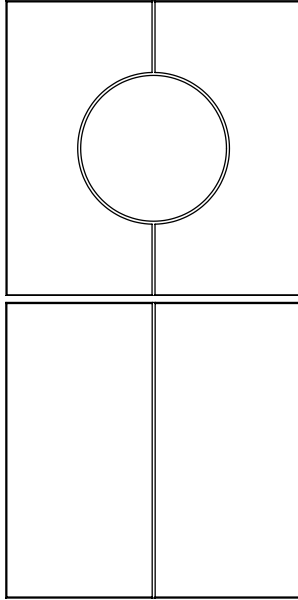

PET Felt
Wall Mounted

Height: 59,5 cm Width 59,5 cm Thickness: 0,12 cm
Height: 23.43" Width 23.43" Thickness: 0.47"

± 0,9 kg | ± 1,98 lbs

Sold exclusively in sets of 8 wall tiles, 1 set = 2 Cosmos and 6 Abacus wall tiles in one color.

BuzziPixl Rib

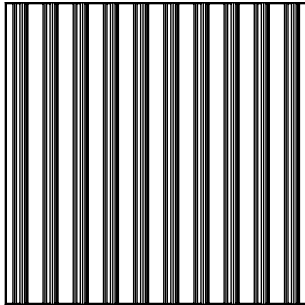

🌲 PET Felt
Wall Mounted

✂ Height: 59,5 cm Width 59,5 cm Thickness: 0,12 cm
✂ Height: 23.43" Width 23.43" Thickness: 0.47"

⚖ ± 0,9 kg | ± 1,98 lbs

... Sold exclusively in sets of 8 wall tiles, 1 set = 8 wall tiles in one color and in one pattern.

BuzziPixl Maze

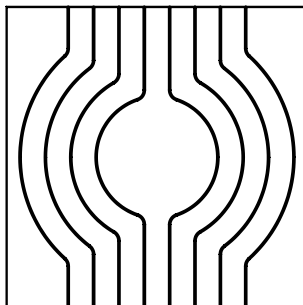

🌲 PET Felt
Wall Mounted

✂ Height: 59,5 cm Width 59,5 cm Thickness: 0,12 cm
✂ Height: 23.43" Width 23.43" Thickness: 0.47"

⚖ ± 0,9 kg | ± 1,98 lbs

... Sold exclusively in sets of 8 wall tiles, 1 set = 8 wall tiles in one color and in one pattern.

Inspirational layouts

BuzziPixl Plain

8 Wall Tiles (=1 set)

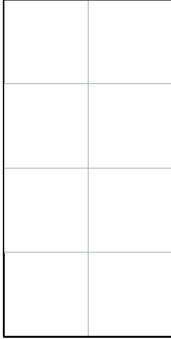

32 pcs (=4 sets)

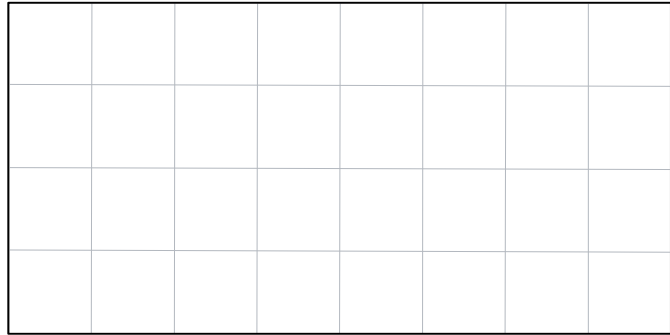

BuzziPixl Parallel Up

8 Wall Tiles (=1 set)

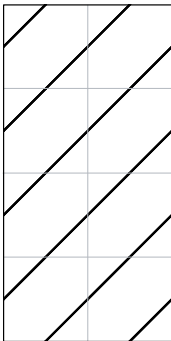

32 pcs (=4 sets)

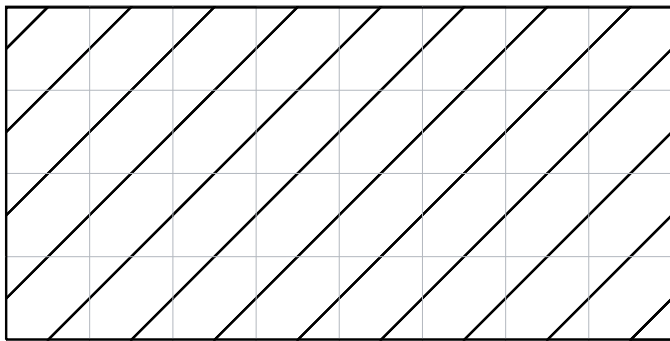

BuzziPixl Parallel Down

8 Wall Tiles (=1 set)



32 pcs (=4 sets)

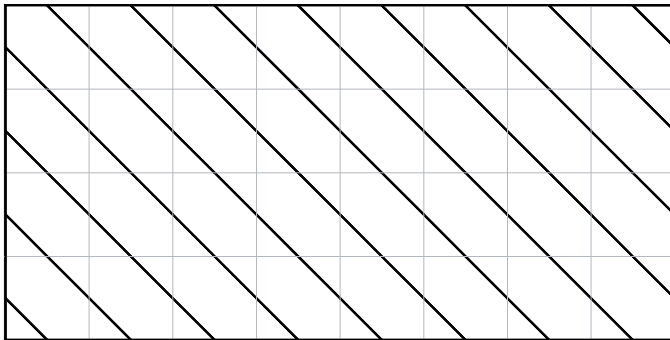

BuzziPixl Parallel Up | Down

16 pcs Parallel Up | 16 pcs Parallel Down

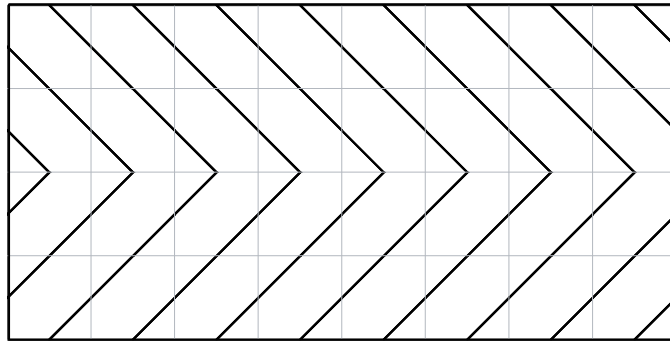

BuzziPixl Parallel Up | Down

16 pcs Parallel Up | 16 pcs Parallel Down

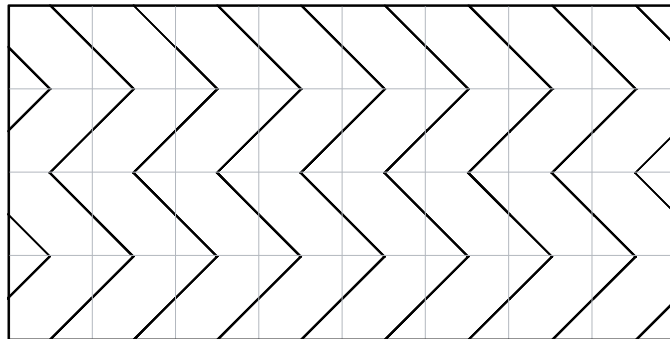

BuzziPixl Geo

8 Wall Tiles (=1 set)

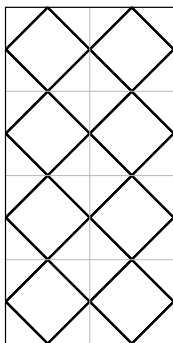

32 pcs (=4 sets)

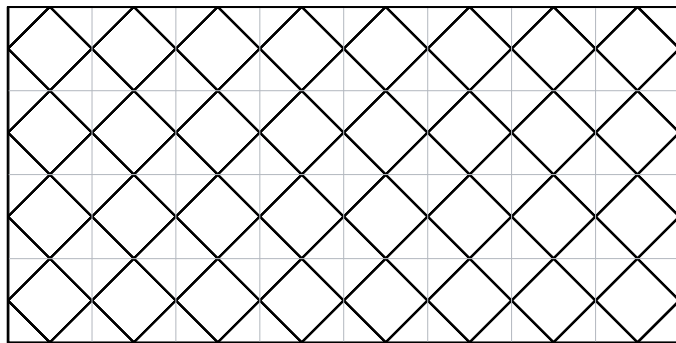

BuzziPixl Parallel Down | Geo

16 pcs Parallel Down | 16 pcs Geo

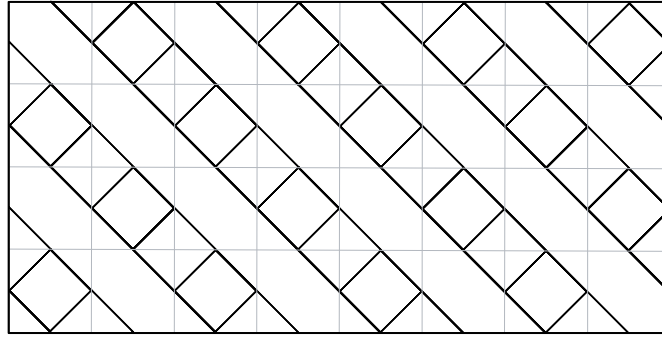

BuzziPixl Cosmos

8 Wall Tiles (=1 set)

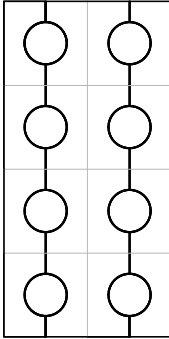

32 pcs (=4 sets)

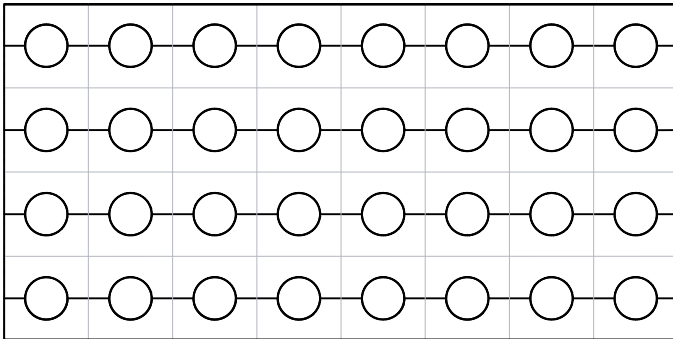
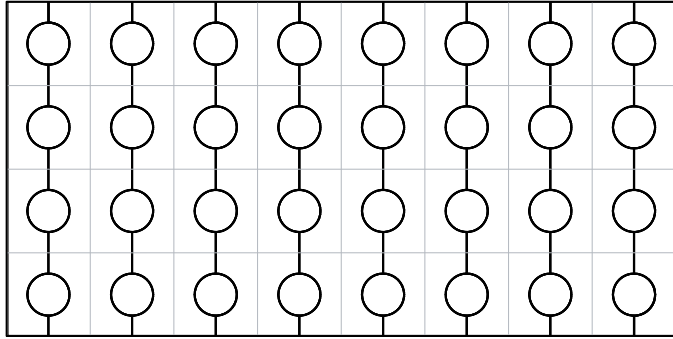

BuzziPixl Abacus

8 Wall Tiles (=1 set)

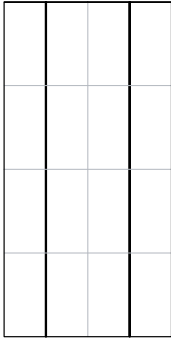

32 pcs (=4 sets)

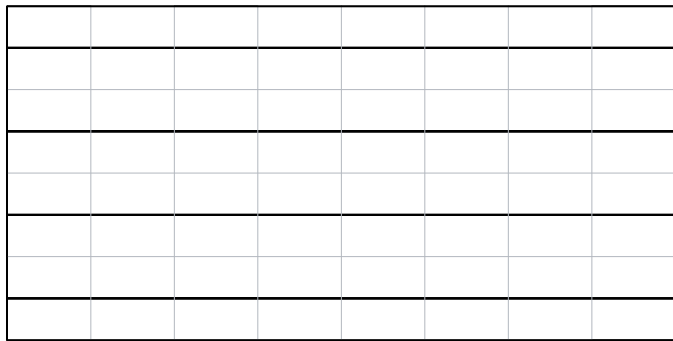
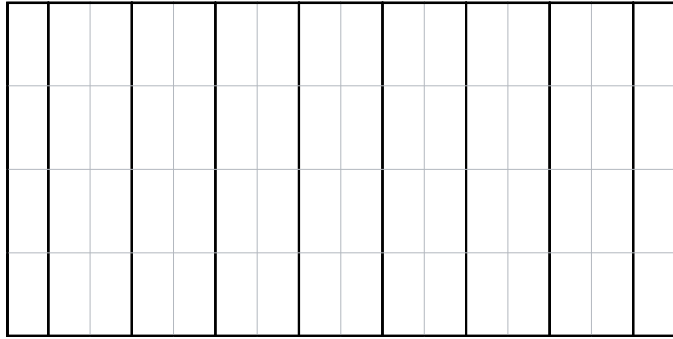

BuzziPixl Cosmos Abacus Combi 1

8 Wall Tiles (=1 set)

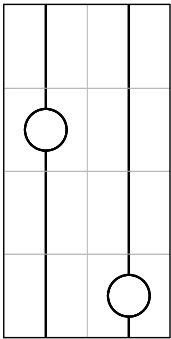

32 pcs (=4 sets)

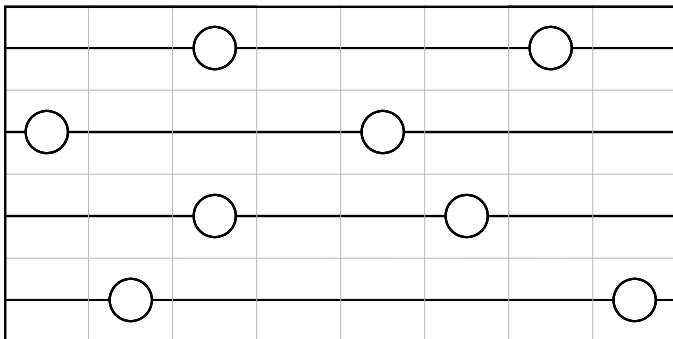
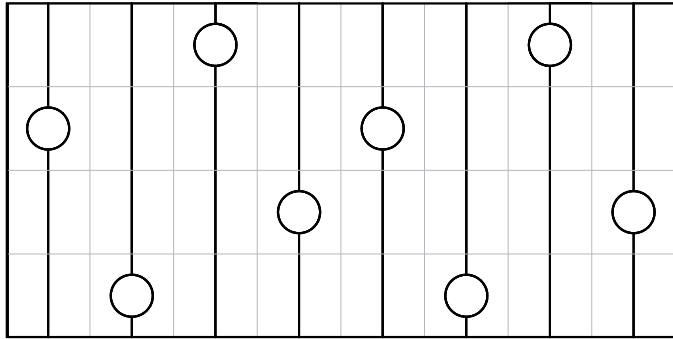

BuzziPixl Rib

8 Wall Tiles (=1 set)

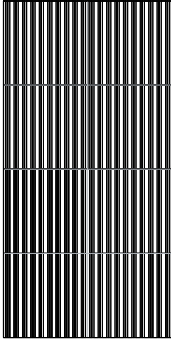

32 pcs (=4 sets)

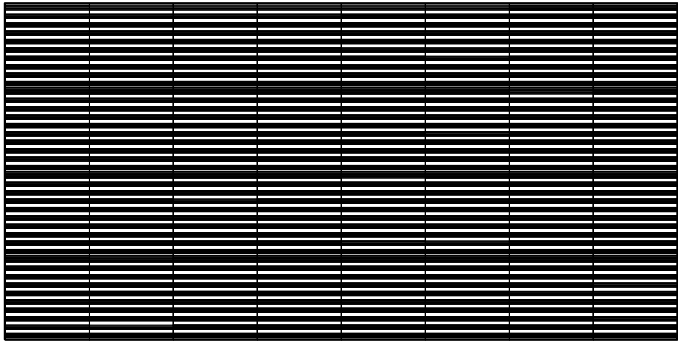
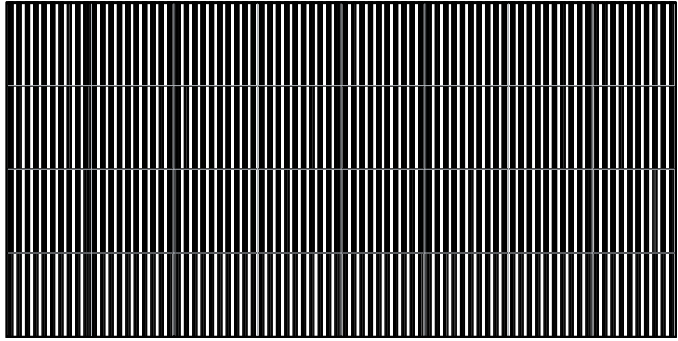

BuzziPixl Maze

8 Wall Tiles (=1 set)

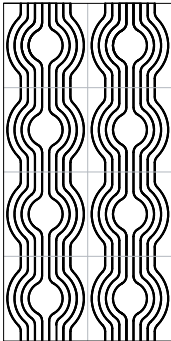

32 pcs (=4 sets)

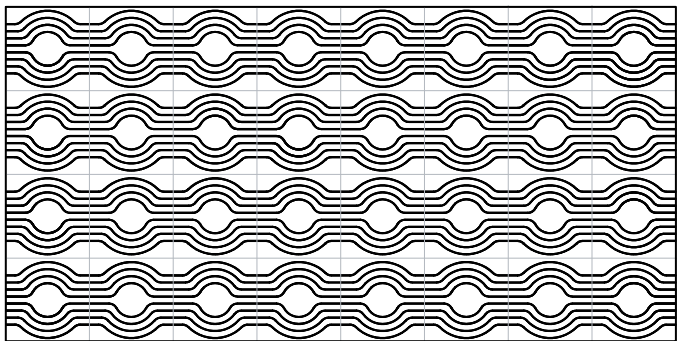
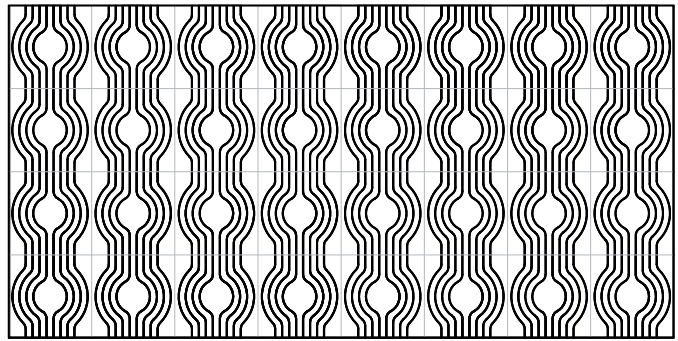

BuzziPixl Snap

28+7 Wall Tiles

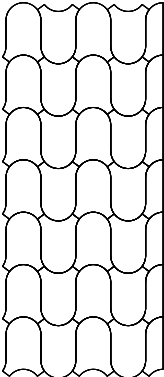

112 pcs (=4 sets)

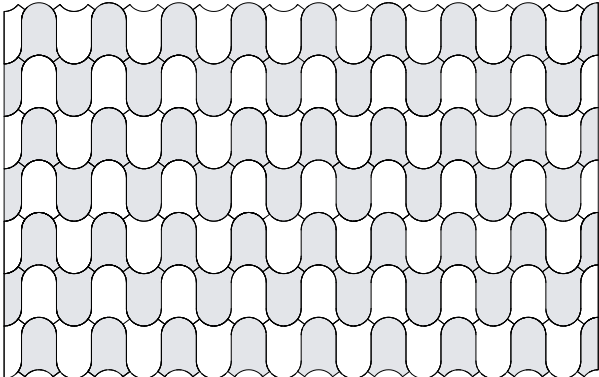

Mounting

BuzziPixl can be mounted directly onto the wall. We recommend using a standard polymer construction adhesive or contact adhesive. It is the installer's responsibility to ensure the chosen adhesive is suitable for the intended application and substrate.

Please note that the adhesive is not included with the Wall Tiles but is readily available at any construction materials store.

PET Felt features natural color variation. For optimal visual consistency, install tiles in the same orientation.

Fabrics

PET Felt

Composition 60% Recycled PET Felt

Weight 2.300 g/m² | 67.8 oz/yd²

Width 120 cm | 47.24"

Length 280 cm | 110.24"

Thickness 12mm | 0.47"

Flammability EU: EN 13501-1:2018 Class B-s1,d0

Maintenance For dust removal light vacuuming with a soft nozzle is recommended on a regular basis. For stain removal, patch test on a concealed section first. Spot clean according to the industry standards.

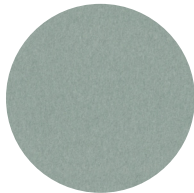

Sage 20

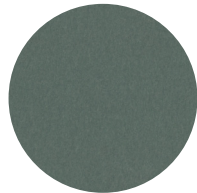

Eucalyptus 22

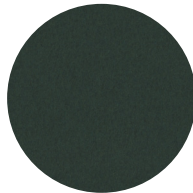

Pine 25

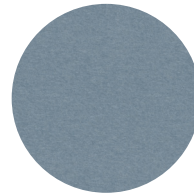

Glacier 31

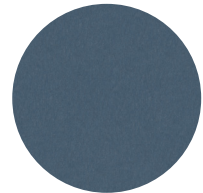

Slate 32

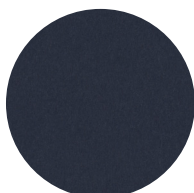

Midnight 36



Coral 41

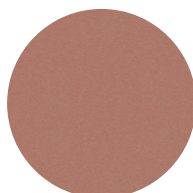

Salmon 44

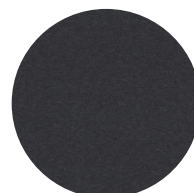

Charcoal 50



Oat 57

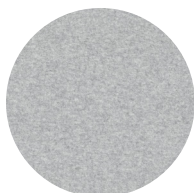

Frost 58



Cream 63

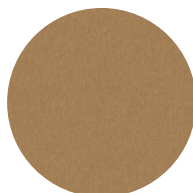

Ochre 65

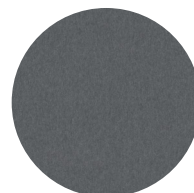

Smoke 71

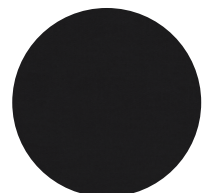

Onyx 87

Material

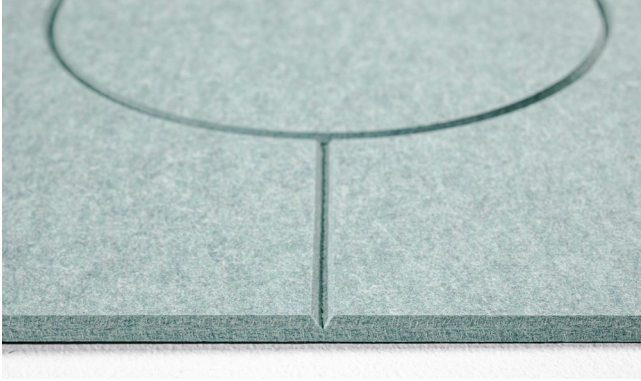

The patterns of the BuzziPixl are created with V-shaped grooves.

Dimensions

BuzziPixl

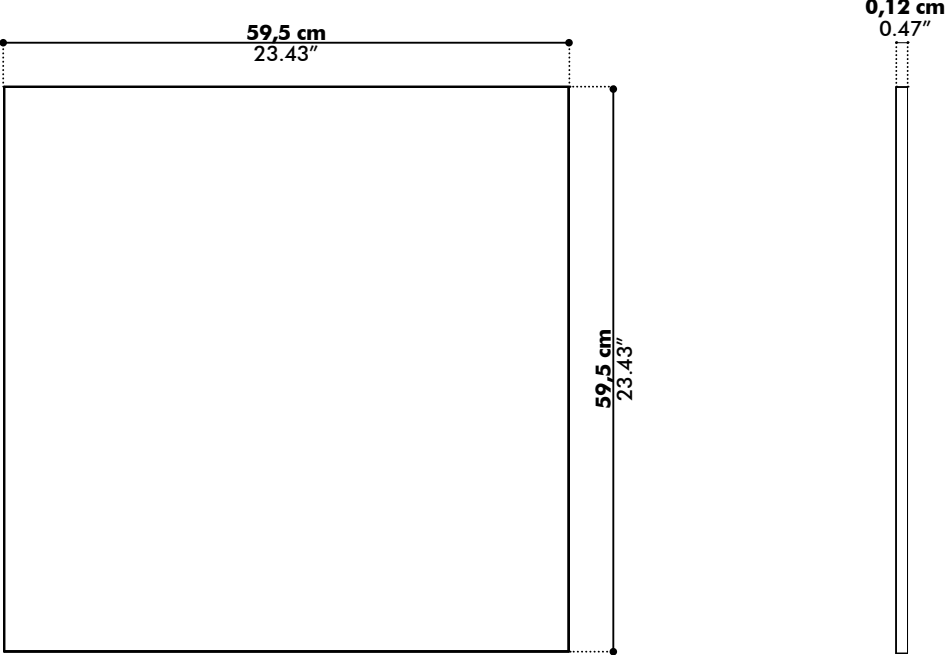

BuzziPixl Snap Full

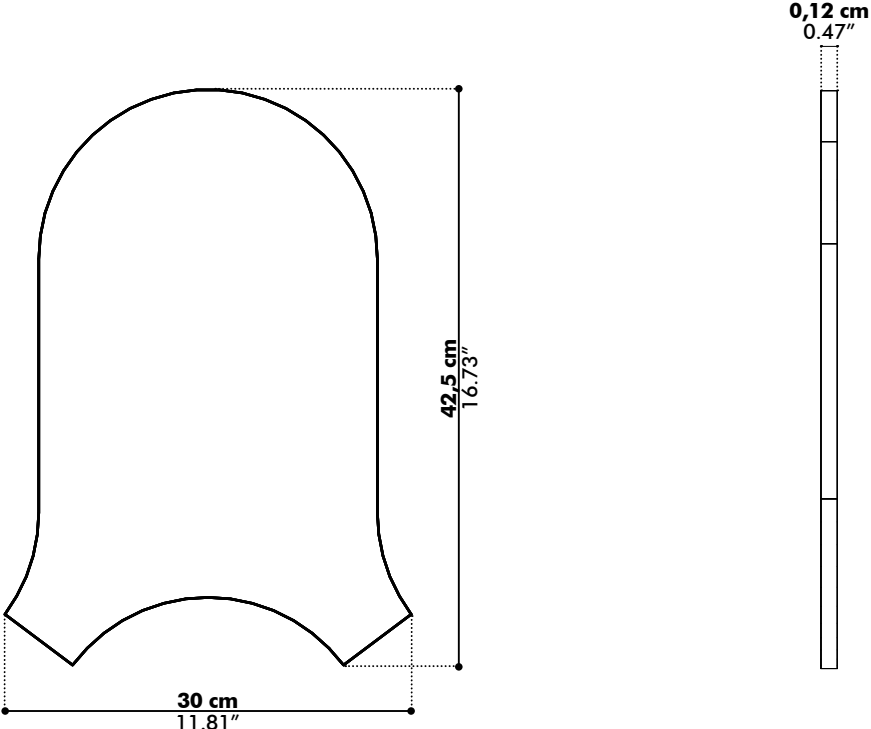

BuzziPixl Snap Half

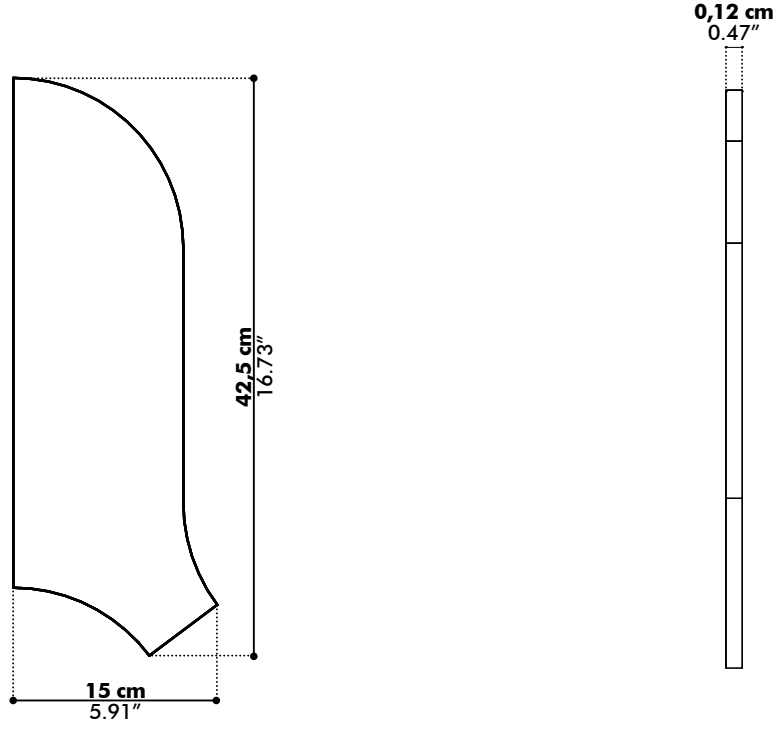

Acoustics

BuzziPixl

Absorption coefficient

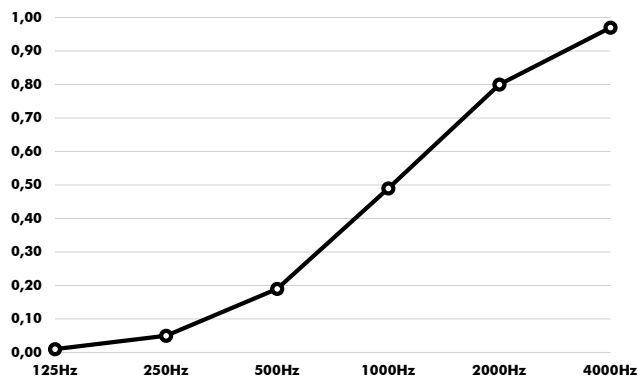

Hz	α^s
125	0.01
250	0.05
500	0.19
1000	0.49
2000	0.80
4000	0.97

Absorption values

α_w (ISO 11654) **0.25**

NRC (ASTM - C423) **0.40**

SAA (ASTM-C423) **0.38**

Class (ISO 11654) **D**

Glossary

All calculations are based on accredited lab measurements, official document available on www.Buzzi.Space

Definitions

α	Weighted absorption coefficient	(ISO 11654)
NRC	Noise reduction coefficient	(ASTM - C423)
SAA	Sound absorption average	(ASTM - C423)

Classification of sound absorbers NEN-EN-ISO 11654

A	0.90 0.95 1.0
B	0.80 0.85
C	0.60 0.65 0.70 0.75
D	0.03 0.55
E	0.15 0.25