

---

# BuzziTent

## Product Specification Sheet

---

This document contains technical information about the BuzziTent

---







## Circular by Nature. Acoustic by Design.

Designed by Alain Gilles, BuzziTent is a high-performance suspended acoustic ceiling element inspired by the rhythm and shelter of open-air tent structures. Engineered for superior mid-to-high frequency absorption, it creates quieter, calmer interiors while maintaining openness and architectural lightness. Crafted from 60% recycled PET felt and designed to be 100% disassemblable and recyclable, BuzziTent balances acoustic performance with a strong commitment to circular design.

Design by Alain Gilles

---

## General

-  BuzziTent  
Fixing: Ceiling Suspended
-  PET Felt  
Black or Alu cables 2 m or 5 m | 78.74" or 196.85"
-  Optional: Deco Ridge in black  
Optional: Ridge Connector in black
-  If installing on suspended ceiling, verify load capacity prior to installation.

---

## Acoustics



Absorption



Mid tone



High tone

---

## Content

Configurations	3
Fabrics	4
Components	5
Fixing System	6
Dimensions	7

# Configuration

---

## BuzziTent Ceiling Suspended

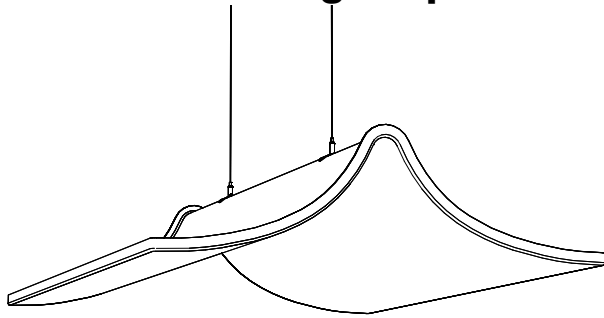

PET Felt



Length: 140 cm    Width: 95 cm    Height: 25 cm  
Length: 55.12"    Width: 37.40"    Height: 0.98"



5,4 kg | 11.90 lbs

Black or Alu cables 2 m or 5m  
78.74" or 196.85"



Optional: Deco Ridge  
Ridge Connector



If installing on suspended ceiling, verify load capacity prior to installation.

# Fabrics

---

## PET Felt

**Composition** 60% Recycled PET Felt

**Weight** 2.300 g/m<sup>2</sup> | 67.8 oz/yd<sup>2</sup>

**Thickness** 7 mm | 0.28"

**Maintenance** For dust removal light vacuuming with a soft nozzle is recommended on a regular basis. For stain removal, patch test on a concealed section first. Spot clean according to the industry standards.

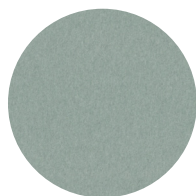

Sage 20

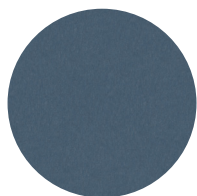

Slate 32

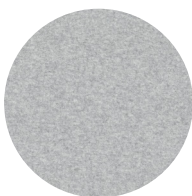

Frost 58



Cream 63

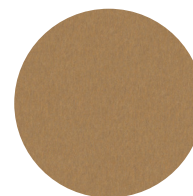

Ochre 65

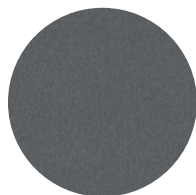

Smoke 71

# Components

---

## Acoustic Panel



Acoustic Panel in PET Felt

---

## Deco Ridge (Optional)

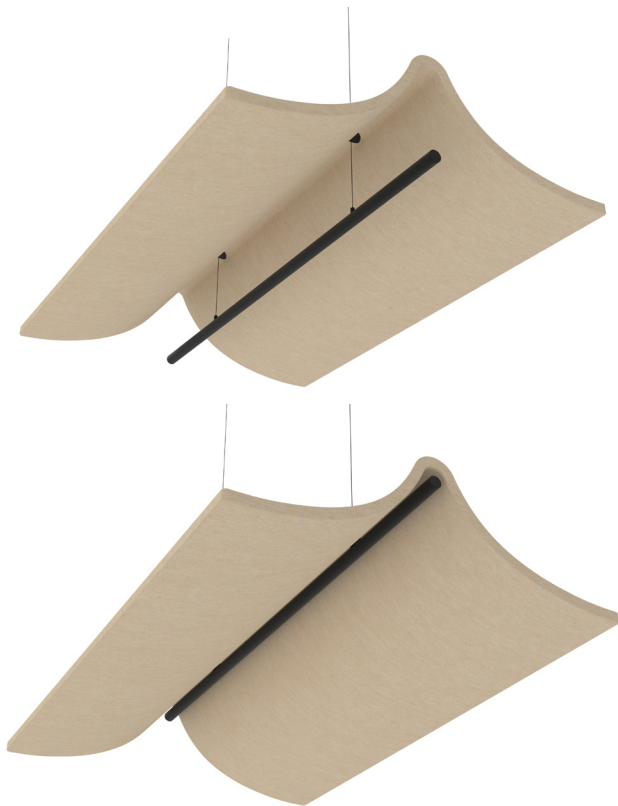

Deco Ridge in black (RAL 9005)  
It adds a refined metal accent to the acoustic panel.  
Distance between deco ridge and the acoustic panel  
is adjustable.

---

## Ridge Connector (Optional)



Ridge Connector in black (RAL 9005)  
It allows to link multiple BuzziTent (incl. Deco Ridge)  
and BuzziTent Light models to create a continuous  
configuration.

1 Ridge Connector = linking 2 models of BuzziTent  
(incl. Deco Ridge) and/or BuzziTent Light

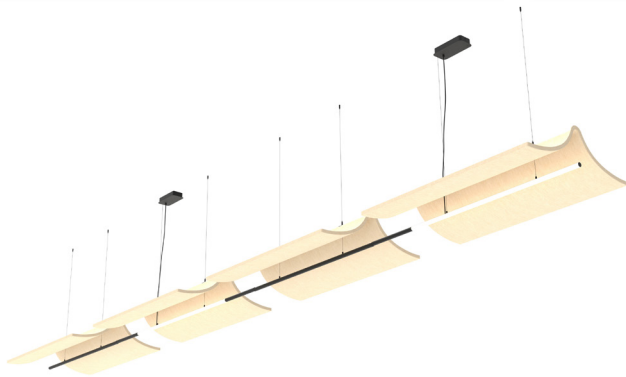

# Fixing System

## Ceiling Suspended

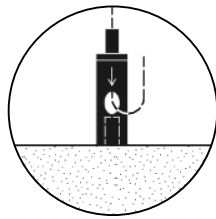
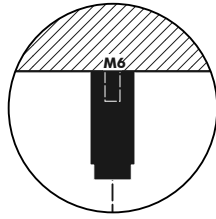
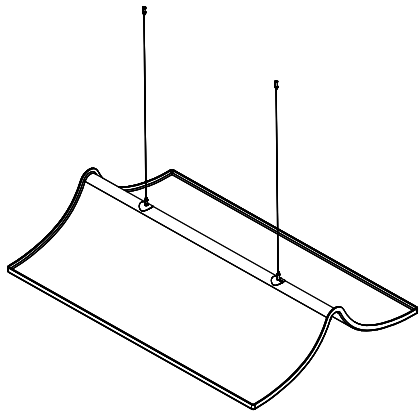

2 cables  
2 m or 5 m | 78.74" or 196.85"  
Black or Alu  
Minimum distance of acoustic panel from ceiling is  
10 cm | 4"

Black  
**Designer's choice**

Alu



# Dimensions

## BuzziTent

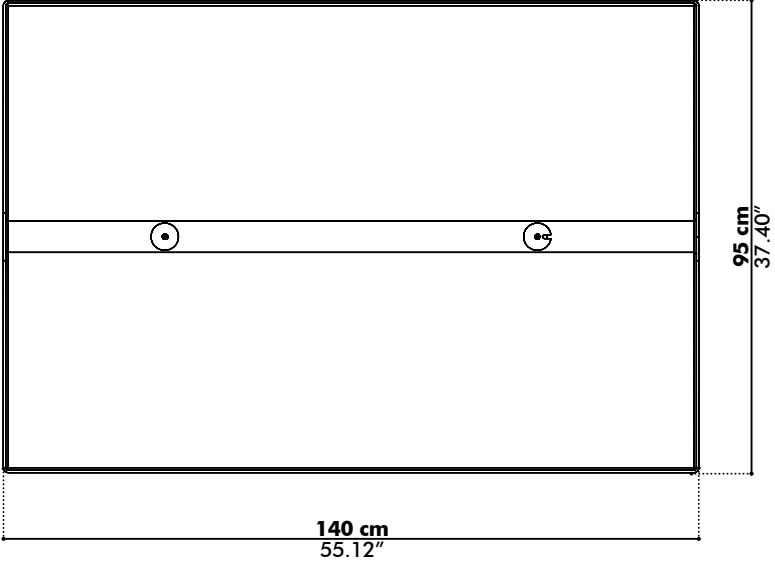
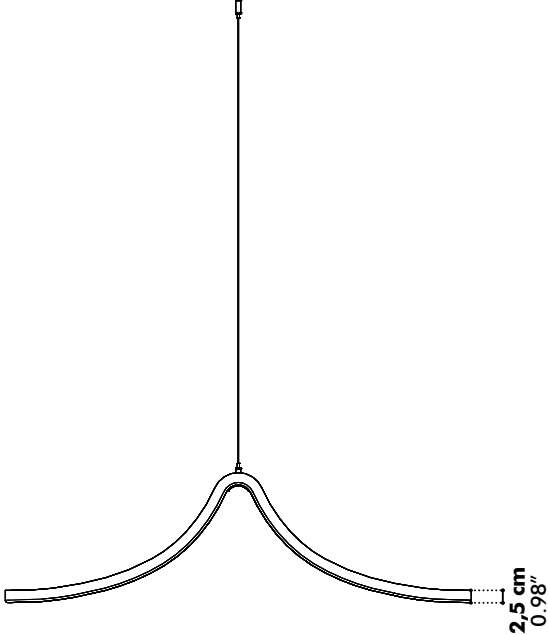
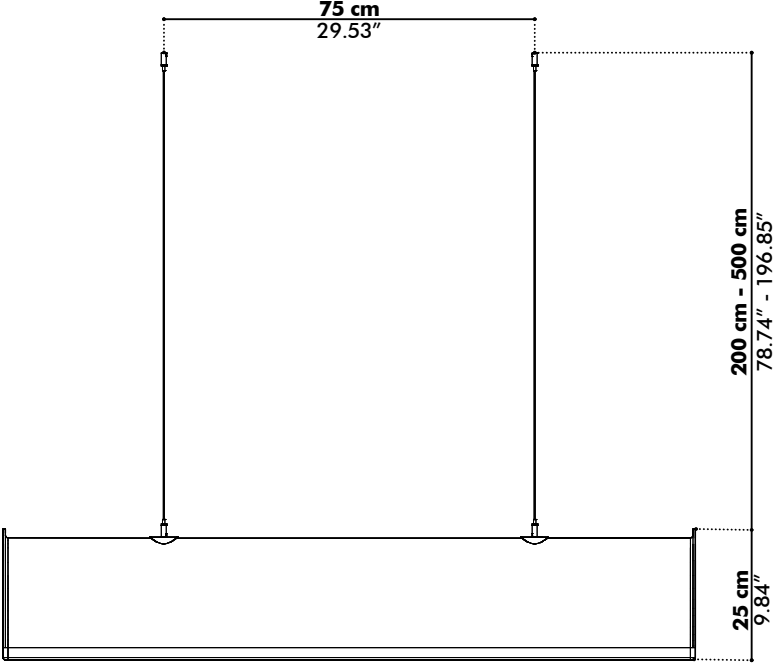

# BuzziTent including Deco Ridge

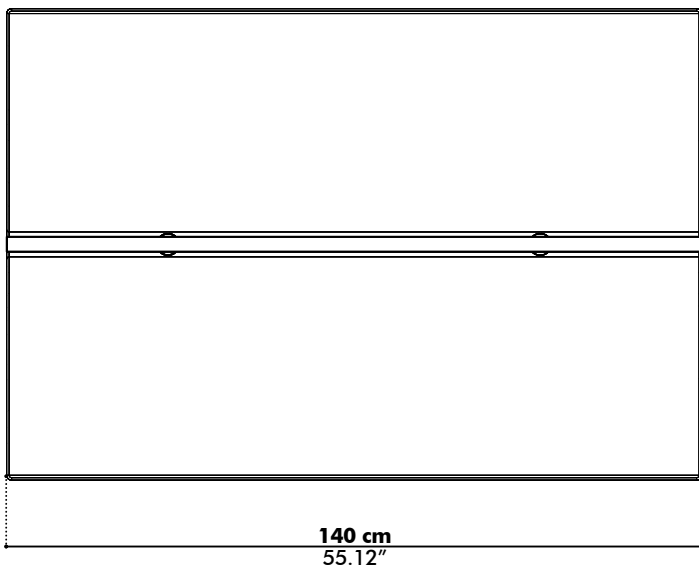
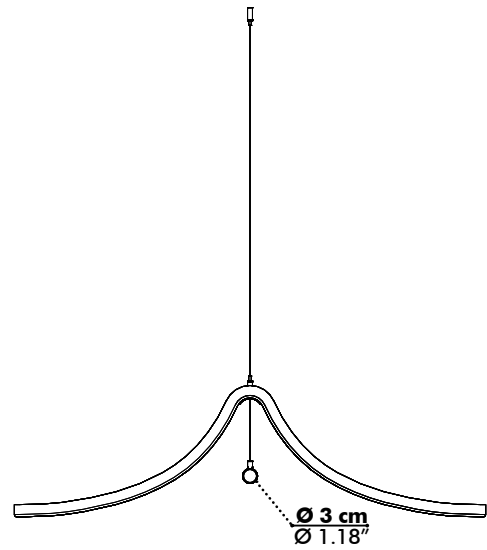
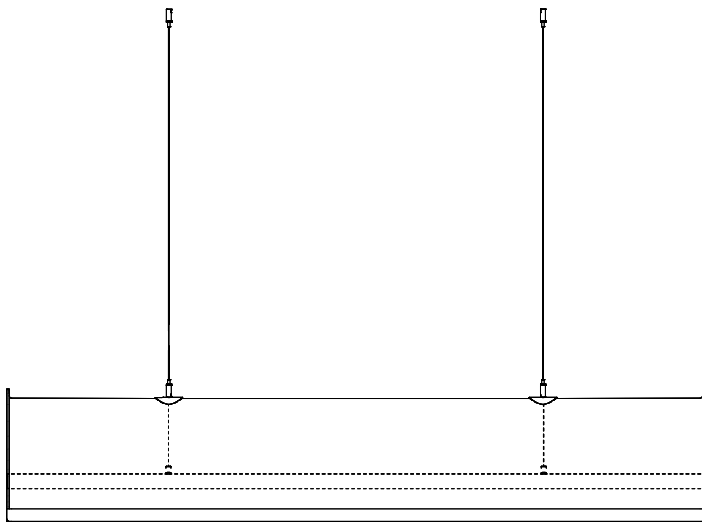

# Ridge Connector

