



## Product Specification Sheet

### BuzziTent Light US

— By Alain Gilles

#### **Circular by Nature. Lighting by Design.**

Designed by Alain Gilles, BuzziTent Light is a high-performance suspended acoustic lighting solution that combines mid-to-high frequency sound absorption with integrated architectural illumination. Crafted from 60% recycled PET felt and designed to be fully disassemblable and 100% recyclable, BuzziTent Light delivers acoustic comfort, lighting performance, and circular design in one integrated ceiling solution.

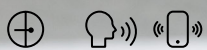

# The Family

**Model**

**BuzziTent Light**

**Lighting Unit**  
**LED Line Glow 140**

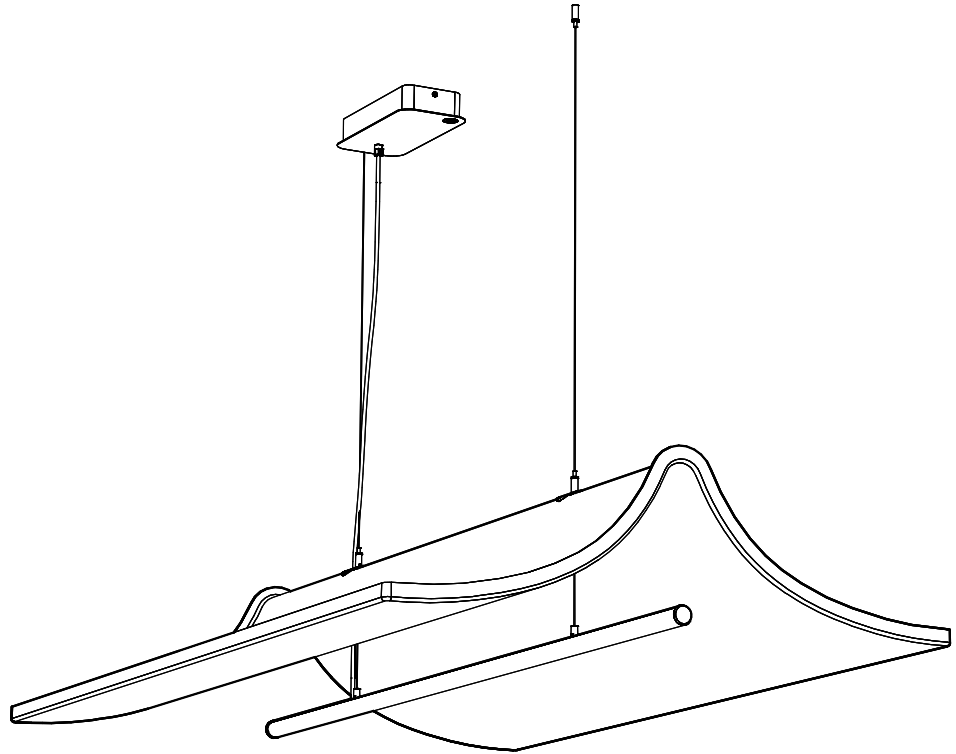

---

Required order information

1. Lighting Options (Voltage Input, Color Temperature, Dimming, Ceiling Canopy Color)
2. Mounting Option
3. PET Felt Color

# Lighting Data

## LED Line Glow 140

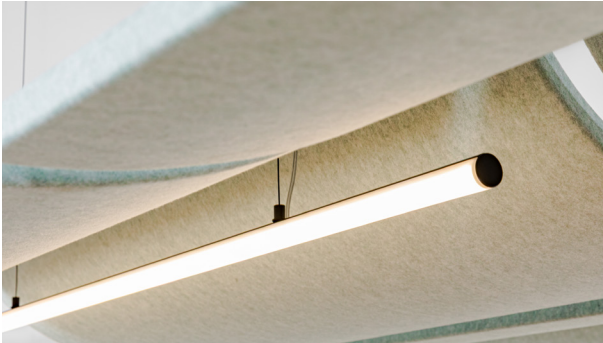

LED Line Glow 140 is a slim LED profile with a rounded cross-section, designed to provide a wide lighting angle and soft, uniform illumination.

The fixture features a powder-coated black profile finished with a polycarbonate milky diffuser. Its integrated light source consists of two LED strips tailored to the dimensions of LED Line Glow 140, ensuring excellent color consistency and smooth dimming performance. The result is a continuous, uniform light distribution without visible dotting.

## BuzziTent Light Lighting options

Lighting Options				Characteristics		Mounting
Voltage Input	Color Temperature	UGR (Diffuser type)	Dimming	Technical	Visual	Options
120-277V	3000K 3500K 4000K	24	0-10V	Power consumption: 31W Light output: 4850 Lm Efficacy: 156 Lm/W CRI: > 90	Black or white ceiling canopy  Tranparant power cable	2 cables 78.74" or 196.85" in Alu or Black



# Photometric Data

## LED Line Glow 140

Cartesian diagram

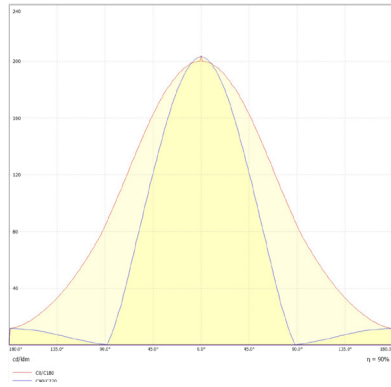

Polar curve

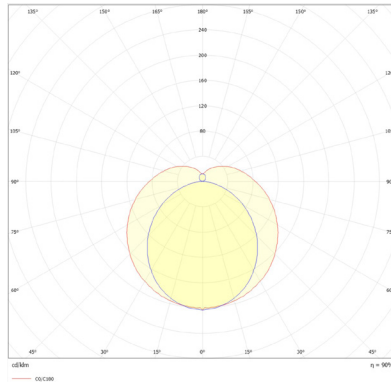

---

## Tips and Tricks - Light Options

To enlight your workplace with optimal lux levels take following measurements into account:

### BuzziTent Light

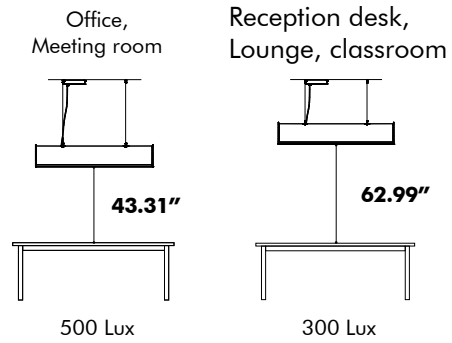

\* According to EN12464

# Product Data

## Fixing System

### Ceiling Suspended

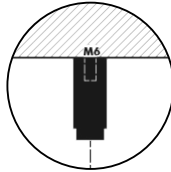
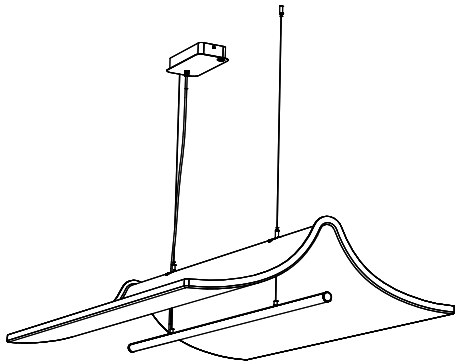

2 cables  
78.74" or 196.85"  
Black or Alu  
Minimum distance of acoustic panel from ceiling is 4"

Black  
**Designer's choice**

Alu

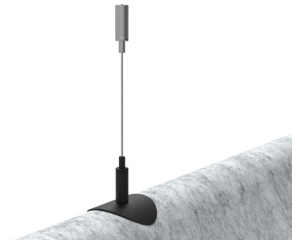

▲ If installing on suspended ceiling, verify load capacity prior to installation.

## Acoustic Panel



Acoustic Panel in PET Felt



Absorption



Mid tone



High tone

---

## Canopy and power cable



Ceiling canopy is available in two finishes powder-coated black (RAL 9005) or white (RAL 9010).

Power cable is transparent.

---

## Ridge Connector (Optional)



Ridge Connector in black (RAL 9005)  
It allows to link multiple BuzziTent (incl. Deco Ridge)  
and BuzziTent Light models to create a continuous  
configuration.

1 Ridge Connector = linking 2 models of BuzziTent  
(incl. Deco Ridge) and/or BuzziTent Light

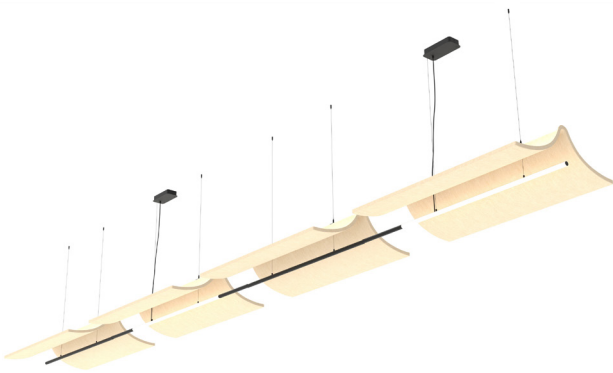

# Dimensions

## BuzziTent Light

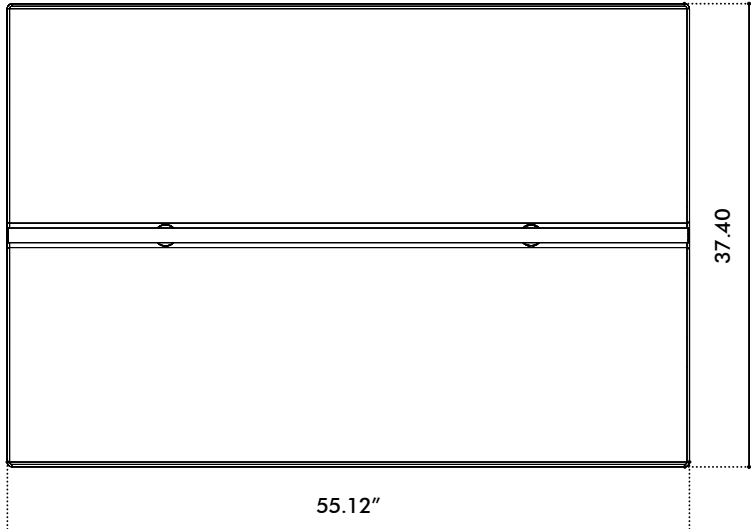
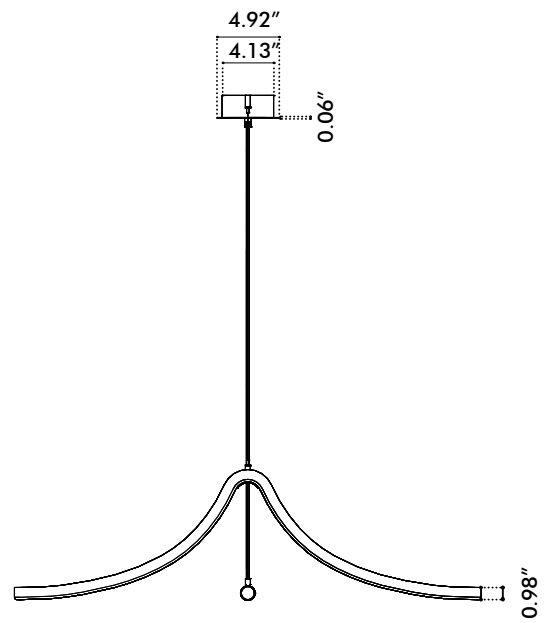
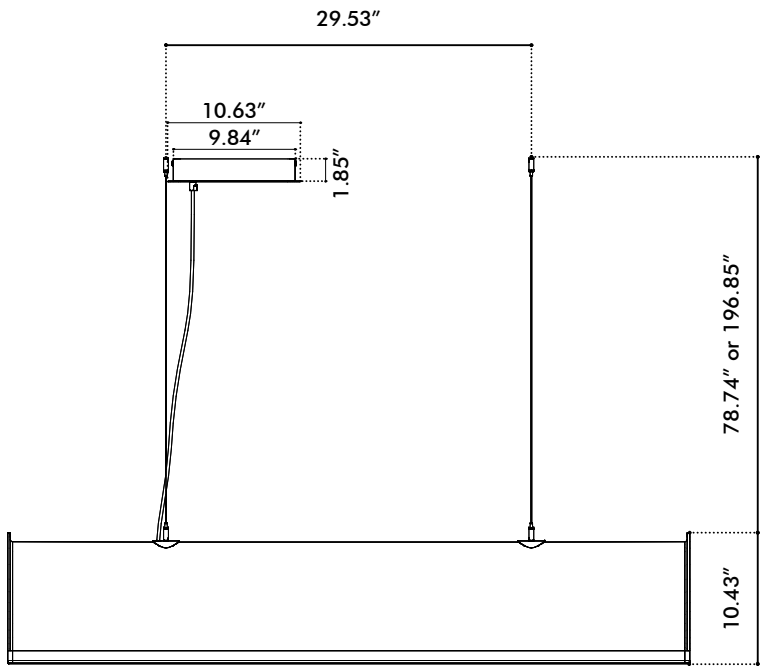

# BuzziRidge Connector

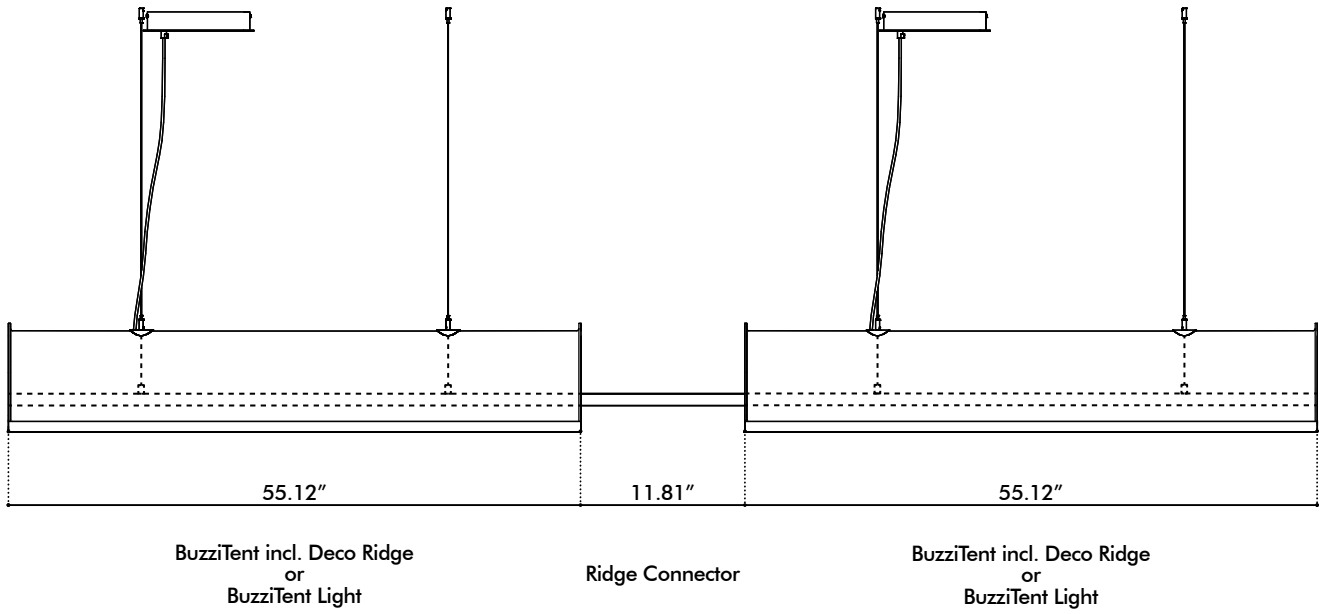
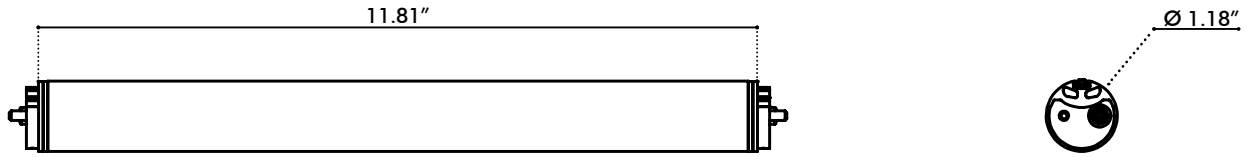

---

# Weights

## BuzziTent Light

16.76 lbs

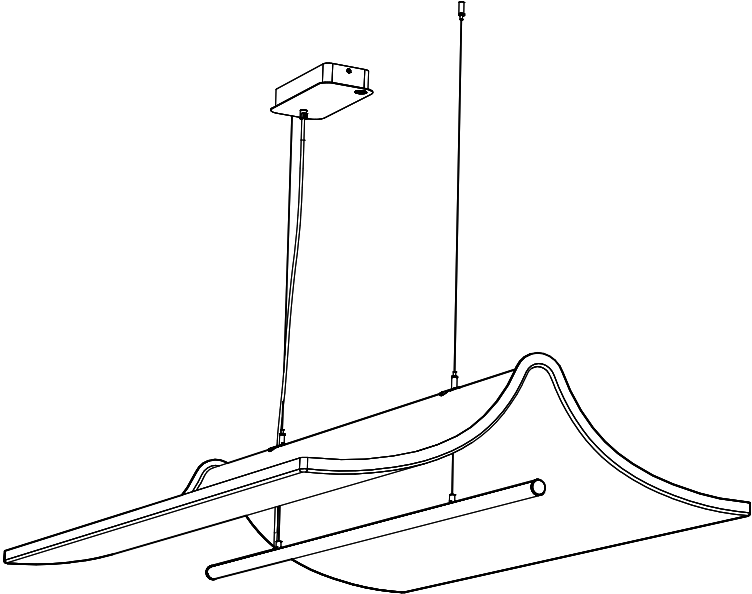

# Fabrics

---

## PET Felt

**Composition** 60% Recycled PET Felt

**Weight** 2.300 g/m<sup>2</sup> | 67.8 oz/yd<sup>2</sup>

**Thickness** 7 mm | 0.28"

**Maintenance** For dust removal light vacuuming with a soft nozzle is recommended on a regular basis. For stain removal, patch test on a concealed section first. Spot clean according to the industry standards.

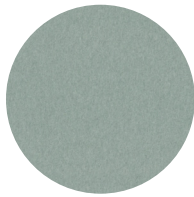

Sage 20

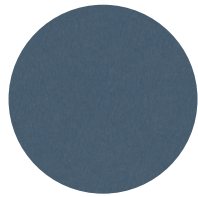

Slate 32

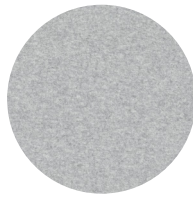

Frost 58



Cream 63

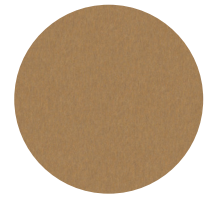

Ochre 65

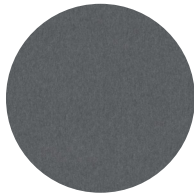

Smoke 71