

CZ Vertical plate clamps

Heavy duty plate clamps with safety lock

Working load limit (WLL) 100 - 30000 kg

These clamps are primarily used for transporting sheet metal and steel plates in the vertical position, as well as lifting and rotating through 180°.

They can also be used for transporting steel constructions and profiles. It is recommended to use a pair of plate clamps in conjunction with a spreader beam for long plate.

Function

The jaw is opened and closed with the locking lever.

The safety lock spring loads the cam jaw, preventing the clamp from opening even when there is no load on the jaw.

Workmanship and parts

These plate clamps are service-friendly, making it easy to exchange parts, which are readily available. Clamp repairs must be done by a trained person.

Product group: I2



Welded shell construction



SCAN ME

INFO

The plate surface of the material being clamped must have a hardness level below HRC 30/Brinell 300.

Product group: I2

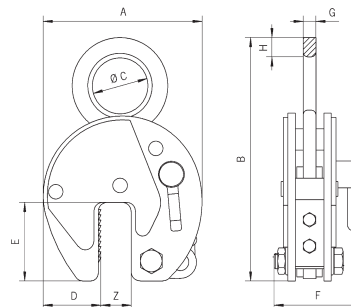

Technical data CZ

Model	Art.-No.	*WLL kg	Jaw (Z) Capacity mm	A mm	B mm	C mm	D mm	E mm	F mm	G mm	H mm	**Weight kg
CZ 1	N4300000092	100 - 1000	0 - 20	140	254	51	48	70	83	13	19	4
CZ 2	N4300000107	200 - 2000	0 - 32	197	323	67	68	93	110	20	10	9
CZ 3	N4300000115	300 - 3000	0 - 32	197	371	80	68	93	110	20	30	10
CZ 4	N501000005	400 - 4000	0 - 32	197	371	80	68	93	129	20	30	10
CZ 4L	N501000006	400 - 4000	30 - 60	228	390	80	68	93	129	20	30	12
CZ 6	N501000021	600 - 6000	0 - 50	293	484	89	95	143	129	25	35	21
CZ 6L	N501000008	600 - 6000	50 - 100	362	524	89	95	143	129	25	35	28
CZ 8	N501000022	800 - 8000	0 - 50	293	492	89	95	143	129	25	42	26
CZ 8L	N501000023	800 - 8000	50 - 100	362	524	89	114	143	129	25	42	32
CZ 10	N501000024	1000 - 10000	0 - 50	293	545	110	95	143	139	25	45	30
CZ 10L	N501000025	1000 - 10000	50 - 100	362	545	110	114	143	139	25	45	37
CZ 15	N501000015	1500 - 15000	0 - 50	360	613	130	125	162	204	45	55	75
CZ 15L	N501000016	1500 - 15000	50 - 100	460	678	130	175	162	204	45	55	88
CZ 20	N501000017	2000 - 20000	0 - 65	462	755	130	165	210	235	45	65	123
CZ 20L	N501000018	2000 - 20000	65 - 130	560	805	130	195	210	235	45	65	136
CZ 30	N501000019	3000 - 30000	0 - 65	462	732	60	165	210	295	65	-	195
CZ 30L	N501000020	3000 - 30000	65 - 130	560	797	60	195	210	295	65	-	295

PLEASE NOTE: Units are supplied as standard with a hook ring. Link fitting and chain are available on request as a special order except CZ30/L which is supplied with the link as standard. *Per clamp **Weight per clamp with hook ring / Standard length of chain = 4-6 links