



Depicted rubber buffers are optionally available!



**EXPERIENCE THE
ADVANTAGE OF 360°**

Yalelift 360

YL IT – Hand chain hoist
with integrated push or with
integrated geared trolley

Capacity 500 - 20000 kg

The combination of the Yalelift 360 with a low headroom manual trolley provides even more flexibility in the application.

Features

- All units of this series up to a capacity of 3000 kg are built with a single chain fall, the min. headroom (Dim. A) has been further reduced. Ideal for applications with low ceilings and limited headroom.
- The approved and almost stepless adjustment system of the trolley enables the simple and quick assembly due to adjusting nuts.
- Trolleys up to 5t capacity are offered for two beam ranges; range A for a flange width of up to 180 mm is standard and covers approx. 80% of all applications. Conversion to range B for beam width up to 300 mm can be easily accomplished.
- The trolley wheels are designed for a max. beam profile incline of 14% (DIN 1025-part 1), excellent rolling features are guaranteed by pre-lubricated, encapsulated ball bearings.
- Anti-drop and anti-tilt devices as standard.

Options

- Adjustable overload protection device.
- Chain container
- Rubber buffers
- Corrosion resistant version
- Beam locking device to secure the unloaded hoist with integrated trolley in a fixed position on the beam (park position e.g. on ships).

UPGRADE
SIMPLE & FLEXIBLE
FROM Yalelift 360 TO Yalelift IT

Technical data Yalelift ITP - with integrated push trolley

Model	Art.-No.	Capacity in kg/ Number of chain falls	Size	Beam flange width b mm	Beam flange thickness t max. mm	Curve radius min. m	Weight at standard lift (3 m) kg
YLITP 500	N04900044	500/1	A	50 - 180	19	0.9	20
YLITP 1000	N04900045	1000/1	A	50 - 180	19	0.9	27
YLITP 2000	N04900046	2000/1	A	58 - 180	19	1.15	44
YLITP 3000	N04900047	3000/1	A	74 - 180	27	1.5	77
YLITP 5000	N04900020	5000/2	A	98 - 180	27	2.0	125
YLITP 500	-	500/1	B	180 - 300	19	0.9	21
YLITP 1000	-	1000/1	B	180 - 300	19	0.9	29
YLITP 2000	-	2000/1	B	180 - 300	19	1.15	46
YLITP 3000	-	3000/1	B	180 - 300	27	1.4	79
YLITP 5000	-	5000/2	B	180 - 300	27	1.8	129

Technical data Yalelift ITG - with integrated geared trolley

Model	Art.-No.	Capacity in kg/ Number of chain falls	Size	Beam flange width b mm	Beam flange thickness t max. mm	Curve radius min. m	Weight at standard lift (3 m) kg
YLITG 500	N04900056	500/1	A	50 - 180	19	0.9	24
YLITG 1000	N04900057	1000/1	A	50 - 180	19	0.9	32
YLITG 2000	N04900058	2000/1	A	58 - 180	19	1.15	49
YLITG 3000	N04900059	3000/1	A	74 - 180	27	1.5	82
YLITG 5000	N04900060	5000/2	A	98 - 180	27	2.0	130
YLITG 500	-	500/1	B	180 - 300	19	0.9	25
YLITG 1000	-	1000/1	B	180 - 300	19	0.9	33
YLITG 2000	-	2000/1	B	180 - 300	19	1.15	50
YLITG 3000	-	3000/1	B	180 - 300	27	1.4	84
YLITG 5000	-	5000/2	B	180 - 300	27	1.8	134
YLITG 10000	N04900061	10000/3	B	125 - 310	40	1.8	202
YLITG 20000 ¹	N04900055	20000/6	B	180 - 310	40	9.5	on request

¹Dimensions on request



COMPLETE SERIES YALELIFT

**CAPACITIES FROM
500-20000 KG**

WITH

**INTEGRATED
PUSH OR GEARED TROLLEY**



We are pleased to send you our new
Atex catalogue in PDF format.

Hoisting Equipment Hand chain hoists

Dimensions Yalelift ITP/ITG

Model	YLIT 500	YLIT 1000	YLIT 2000	YLIT 3000	YLIT 5000	YLIT 10000
A min., mm	245	272	323	382	550	784
A1, mm	158	178	205.5	252	260.5	380
A2, mm	-	-	-	-	-	-
B, mm	17	22	30	38	45	68
C, mm	24	29	35	40	47	68
D, mm	14	19	22	30	37	50
F (Geared trolley), mm	92	92	91	107	149.5	113
H1, mm	24.5	24	23.5	32	30.5	55
I (Push trolley), mm	71.5	71.5	95.5	131	142.5	169
I (Geared trolley), mm	76.5	76.5	98	132.5	148.5	169
L, mm	270	310	360	445	525	430
L1, mm	130	130	150	180	209	200
L2, mm	159	175	207	256	283	261
M, mm	M 18	M 22	M 27	M 30	M 42	M 48
O, mm	60	60	80	112	125	150
P (Geared trolley), mm	108	110	112	112	117	158
T (Area A), mm	280	290	305	320	364	-
T (Area B), mm	400	410	425	440	484	540

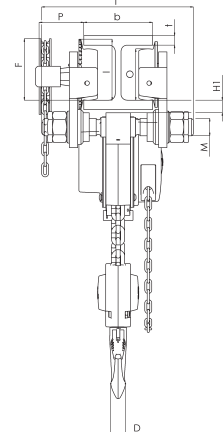
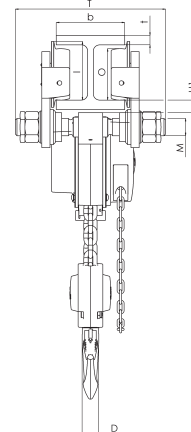
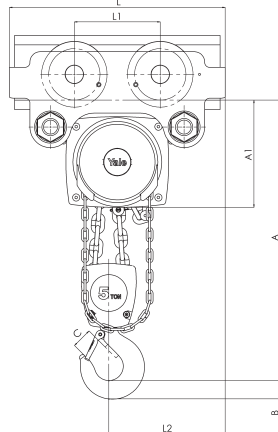
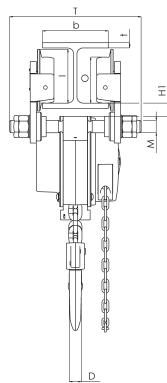
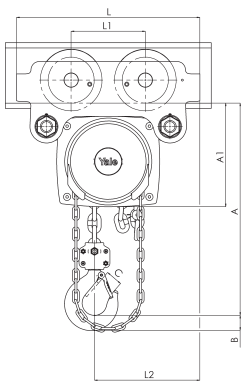

Yalelift ITP, 500 - 3000 kg, single fall

Yalelift ITP/ITG, 5000 kg, double fall

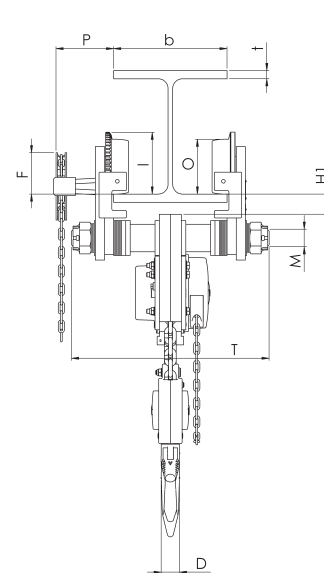
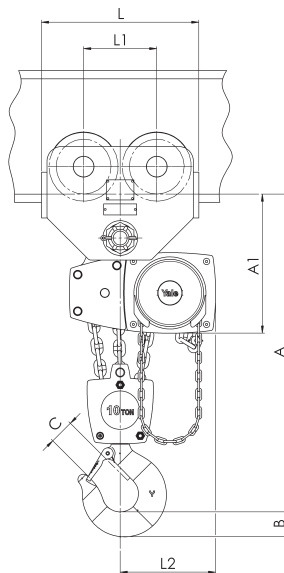
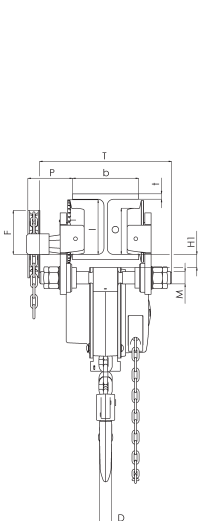
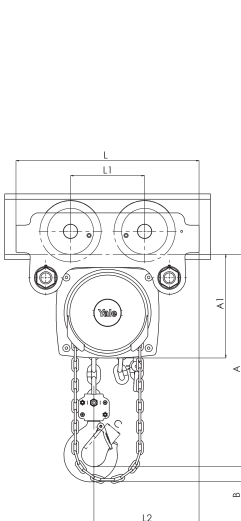

Yalelift ITG, 500 - 3000 kg, single fall

Yalelift ITG, 10000 kg, three falls